

# *XPJ-1682SR-P*

## Operation Manual

### Operations and Maintenance Methods

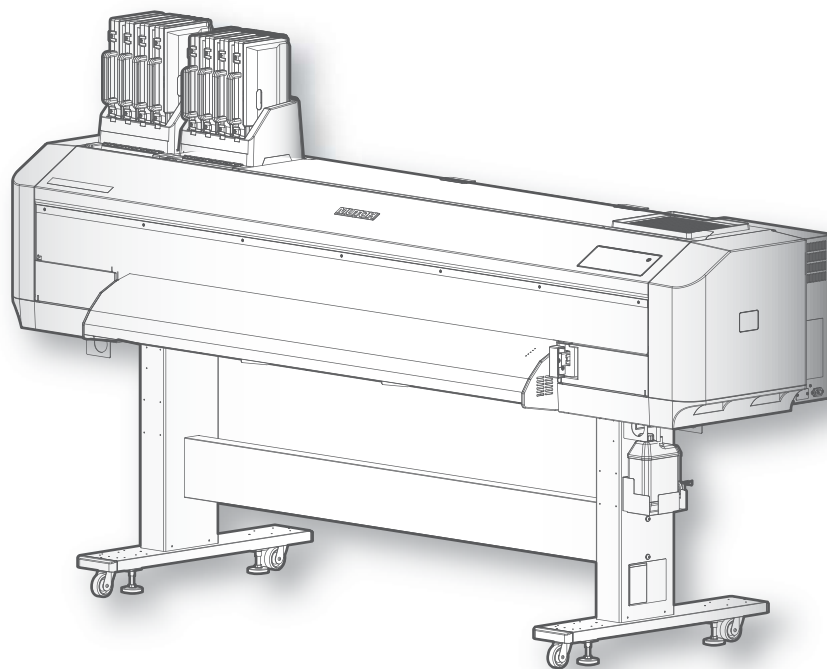

- 
- Unauthorized copying or duplication of the whole or part of the contents of this manual is prohibited.
  - Every care has been taken in writing the contents of this manual, but please contact MUTOH or the dealer you purchased the product from if you find any unclear, erroneous or otherwise unsatisfactory content in the manual.
  - Please be aware that MUTOH will not be liable in any way for failures or accidents that result from handling or operating the printer according to any procedures other than those set forth in this manual.
  - Company names and product names that appear in this manual are registered trademarks of the respective companies.

## For Users in Europe



The CE marking is a mandatory European marking for certain product groups to indicate conformity with the essential health and safety requirements set out in European Directives.

By affixing the CE marking, the manufacturer, his authorized representative, or the person placing the product on the market or putting it into service ensures that the item meets all the essential requirements of all applicable EU directives and that the applicable conformity assessment procedures have been applied.

## For Users in the United States

This equipment has been tested and found to comply with the limits for a Class A digital device, pursuant to Part 15 of the FCC Rules.

These limits are designed to provide reasonable protection against harmful interference when the equipment is operated in a commercial environment.

This equipment generates, uses, and can radiate radio frequency energy and, if not installed and used in accordance with the instruction manual, may cause harmful interference to radio communications.

Operation of this equipment in a residential area is likely to cause harmful interference in which case the user will be required to correct the interference at his own expense.

## Installation Location Requirements

This equipment is not suitable for use in locations where children are likely to be present.

## Chapter 1 Basic Operations

|   |           |
|---|-----------|
| <b>Introduction</b> .....   | <b>9</b>  |
| Main components of your printer .....                                 | 9         |
| Connecting to a Computer.....   | 13        |
| System configurations of this product.....                            | 15        |
| Launching/Displaying/Exiting MUTOH Status Monitor (MSM) .....         | 16        |
| Printing area .....   | 18        |
| Media size.....   | 18        |
| Precautions .....   | 20        |
| <b>Powering ON / OFF</b> .....  | <b>21</b> |
| Turning the power ON.....   | 21        |
| Sleep Mode .....  | 22        |
| Turning the power OFF .....   | 24        |
| <b>Loading a roll media.</b> .....                                    | <b>25</b> |
| Load a roll media into the printer .....                              | 25        |
| <b>Nozzle check and cleaning</b> .....                                | <b>35</b> |
| Nozzle check .....  | 36        |
| Cleaning .....  | 38        |
| <b>Calibrating your printer</b> .....                                 | <b>39</b> |
| Head alignment .....  | 39        |
| Print quality calibration .....                                       | 41        |
| Media feed adjustment .....   | 44        |
| <b>Advanced setting</b> .....   | <b>45</b> |
| Printhead Height .....  | 46        |
| Swapping left and right edge holders depending on the media type..... | 51        |
| Changing holddown pressure using media feed lever.....                | 52        |
| Canceling or reducing pressure rollers individually .....             | 53        |
| <b>Operating from Front panel.</b> .....                              | <b>55</b> |
| Feeding media .....   | 55        |
| Pausing / Restarting printing.....                                    | 55        |
| Canceling printing.....   | 56        |
| Starting printing during warming up .....                             | 56        |
| Cutting media .....   | 57        |
| Menus you can access while printing.....                              | 58        |

## Chapter 2 Advanced Operations

|   |            |
|---|------------|
| <b>Introduction</b> .....   | <b>65</b>  |
| Operating the keys to use the menus .....                                   | 65         |
| Panel setup menu .....  | 67         |
| <br>  |            |
| <b>Menu 1: Setup</b> .....  | <b>72</b>  |
| Setup 1: User Type .....  | 72         |
| Setup 2: Spitting .....   | 88         |
| Setup 3: Side Margin .....  | 89         |
| Setup 4: Media Initial .....  | 90         |
| Setup 5: Media Width .....  | 90         |
| Setup 6: Output Mode .....  | 91         |
| Setup 7: Method of Cut .....  | 92         |
| Setup 8: Origin .....   | 93         |
| Setup 9: Prevent Stick menu .....   | 94         |
| Setup 10: Standby Heating .....   | 94         |
| Setup 11: Head Travel .....   | 94         |
| Setup 12: Multi Strike .....  | 95         |
| Setup 13: Strike Wait .....   | 95         |
| Setup 14: Slant Check .....   | 95         |
| Setup 15: Auto Cleaning .....   | 96         |
| Setup 16: Exhaust Fan .....   | 97         |
| Setup 17: Longstore .....   | 98         |
| Setup 18: Initialization .....  | 98         |
| Setup 19: Header Dump .....   | 99         |
| Setup 20: Head Select .....   | 100        |
| Setup 21: Select Nozzle .....   | 101        |
| Setup 22: Heater Control .....  | 103        |
| Setup 23: Start Feed .....  | 103        |
| Setup 24: Internal LED Lights .....   | 104        |
| Setup 25: Front Interlace .....   | 104        |
| Setup 26: Auto Nozzle Check (Requiring the optional drop sensor unit) ..... | 105        |
| Setup 27: Power Off .....   | 107        |
| Setup 28: Temporary .....   | 108        |
| <br>  |            |
| <b>Menu 2: Test Print</b> .....   | <b>109</b> |
| Test Print 1: Nozzle Check .....  | 109        |
| Test Print 2: Nozzle Check F .....  | 110        |
| Test Print 3: Mode Print .....  | 110        |
| Test Print 4: Setup List .....  | 111        |
| Test Print 5: Palette .....   | 111        |
| Test Print 6: Adjust Head .....   | 112        |
| <br>  |            |
| <b>Menu 3: Cleaning</b> .....   | <b>116</b> |
| Menu3: Cleaning .....   | 116        |
| <br>  |            |
| <b>Menu 4: Menu Option</b> .....  | <b>117</b> |
| Menu4: Menu Option .....  | 117        |
| <br>  |            |
| <b>Menu 5: System Info</b> .....  | <b>118</b> |

|  |            |
|--|------------|
| Ink Status .....                       | 118        |
| Life Times .....                       | 119        |
| <b>Menu 6: Sleep Mode .....</b>        | <b>120</b> |
| Sleep Mode 1: Cleaning Setting .....   | 120        |
| Sleep Mode 2: Auto Sleep Timer .....   | 120        |
| Sleep Mode 3: Start.....               | 121        |
| <b>Menu 7: Initial Settings .....</b>  | <b>122</b> |
| Initial Settings 1: Language .....     | 122        |
| Initial Settings 2: Temperature .....  | 122        |
| Initial Settings 3: Length .....       | 123        |
| Initial Settings 4: IP Address.....    | 123        |
| Initial Settings 5: Subnet Mask .....  | 123        |
| Initial Settings 6: Gateway .....      | 124        |
| Initial Settings 7: Alert Buzzer ..... | 124        |
| <b>Menu 8: Job Status .....</b>        | <b>125</b> |
| <b>Menu9: Roll Length Manage .....</b> | <b>126</b> |
| Roll Length Manage1: Print.....        | 127        |
| Roll Length Manage2: Simple Print..... | 127        |
| Roll Length Manage3: Scan .....        | 128        |
| Roll Length Manage4: Roll Length ..... | 129        |
| Roll Length Manage5: Auto Scan .....   | 130        |
| Roll Length Manage6: Auto Print.....   | 131        |
| <b>Menu10: Media Adjustment .....</b>  | <b>132</b> |
| <b>Menu11: CR Maintenance.....</b>     | <b>134</b> |
| <b>Menu chart .....</b>                | <b>135</b> |
| Setting menu 1.....                    | 135        |
| Setting menu 2.....                    | 136        |
| Setting menu 3.....                    | 137        |
| Menu during printing.....              | 138        |

## Chapter 3 Maintenance

|   |            |
|---|------------|
| <b>Maintenance.....</b>                         | <b>140</b> |
| <b>Checking ink and replacing ink bag .....</b> | <b>141</b> |
| Checking ink level .....                        | 141        |
| When it becomes time to replace ink bag .....   | 142        |
| Replacing ink bag .....                         | 142        |
| <b>Emptying waste ink tank .....</b>            | <b>145</b> |
| Emptying waste ink tank.....                    | 145        |

|   |            |
|---|------------|
| <b>Cleaning .....</b>                                   | <b>147</b> |
| Head cleaning .....                                     | 147        |
| Soak Cleaning.....                                      | 149        |
| Cleaning of cleaning wiper .....                        | 150        |
| Cleaning around the capping unit .....                  | 153        |
| Cleaning around the print head .....                    | 155        |
| Cleaning the color sensor.....                          | 157        |
| Inside cleaning.....                                    | 159        |
| <br>  |            |
| <b>Replacing consumable parts .....</b>                 | <b>160</b> |
| Replacing absorption material for the flushing box..... | 160        |
| Replacing Cutter .....                                  | 162        |
| Replacing the cleaning wiper.....                       | 164        |
| <br>  |            |
| <b>Moving or transporting the printer.....</b>          | <b>167</b> |
| Moving the printer .....                                | 167        |
| Transporting the printer.....                           | 168        |
| Long-term storage .....                                 | 169        |
| Performing initial charging after head cleaning .....   | 174        |

## Chapter 4 Appendix

|   |            |
|---|------------|
| <b>Messages and Error Messages .....</b>            | <b>178</b> |
| Status messages .....                               | 178        |
| Error message display and remedies .....            | 180        |
| Error requiring restart .....                       | 184        |
| <br>  |            |
| <b>Troubleshooting.....</b>                         | <b>185</b> |
| Installation and initial setup troubleshooting..... | 185        |
| Boot-up troubleshooting .....                       | 186        |
| Media-related troubleshooting .....                 | 187        |
| Printing-related troubleshooting .....              | 189        |
| The media is jammed .....                           | 193        |
| <br>  |            |
| <b>Specifications of this product .....</b>         | <b>196</b> |
| List of specifications.....                         | 196        |
| <br>  |            |
| <b>Options / Supply list.....</b>                   | <b>199</b> |
| <br>  |            |
| <b>Revision History .....</b>                       | <b>200</b> |

# Chapter 1 Basic Operations

|  |           |
|--|-----------|
| <b>Introduction</b> .....  | <b>9</b>  |
| Main components of your printer .....                                  | 9         |
| Connecting to a Computer .....   | 13        |
| System configurations of this product .....                            | 15        |
| Launching/Displaying/Exiting MUTOH Status Monitor (MSM) .....          | 16        |
| Printing area .....  | 18        |
| Media size .....   | 18        |
| Precautions .....  | 20        |
| <br>   |           |
| <b>Powering ON / OFF</b> .....   | <b>21</b> |
| Turning the power ON .....   | 21        |
| Sleep Mode .....   | 22        |
| Turning the power OFF .....  | 24        |
| <br>   |           |
| <b>Loading a roll media</b> .....                                      | <b>25</b> |
| Load a roll media into the printer .....                               | 25        |
| <br>   |           |
| <b>Nozzle check and cleaning</b> .....                                 | <b>35</b> |
| Nozzle check .....   | 36        |
| Cleaning .....   | 38        |
| <br>   |           |
| <b>Calibrating your printer</b> .....                                  | <b>39</b> |
| Head alignment .....   | 39        |
| Print quality calibration .....  | 41        |
| Media feed adjustment .....  | 44        |
| <br>   |           |
| <b>Advanced setting</b> .....  | <b>45</b> |
| Printhead Height .....   | 46        |
| Swapping left and right edge holders depending on the media type ..... | 51        |
| Changing holddown pressure using media feed lever .....                | 52        |
| Canceling or reducing pressure rollers individually .....              | 53        |
| <br>   |           |
| <b>Operating from Front panel</b> .....                                | <b>55</b> |
| Feeding media .....  | 55        |
| Pausing / Restarting printing .....                                    | 55        |
| Canceling printing .....   | 56        |
| Starting printing during warming up .....                              | 56        |
| Cutting media .....  | 57        |
| Menus you can access while printing .....                              | 58        |



# Introduction

## Main components of your printer

### Front side

#### Internal LED lights

The lights allows you to inspect inside of the printer or your print during printing.

#### Front cover

Open this cover when loading a roll media or removing a media jam. It is normally closed.

#### Front panel

⇒ Front panel P. 11

#### Media feed lever

Push the lever to lower the pressure rollers to keep the media flat while printing. Pull it to release the media. The holddown pressure can be changed between High and Normal using this lever.

#### Maintenance cover L

Open this cover for cleaning. It is normally closed.

#### Maintenance cover R

Open this cover for cleaning or replacing consumables. It is normally closed.

#### Media guide

A roll media passes over the media guide.

#### Heater

The heater built inside the media guide dries ink.

#### Waste ink tank

Collect waste ink produced during printing and cleaning cycle. Empty the tank as needed.

#### Adjuster

#### Stand

#### Carriage

The print head is installed on the carriage.

#### Pressure rollers

Keep the media in place to ensure proper feeding. The holddown pressure can be individually reduced or canceled by slide lock levers on the pressure rollers.

#### Edge holder

Place it on the edge of the media to prevent media curl while printing. While not printing, slide them to the left and right side edges of the platen.

#### Media cut groove

Manually cut the media along the groove.

#### Cutter

Automatically cut the media after printing.

#### Platen

Media is printed on here. There is an adsorption fan inside.

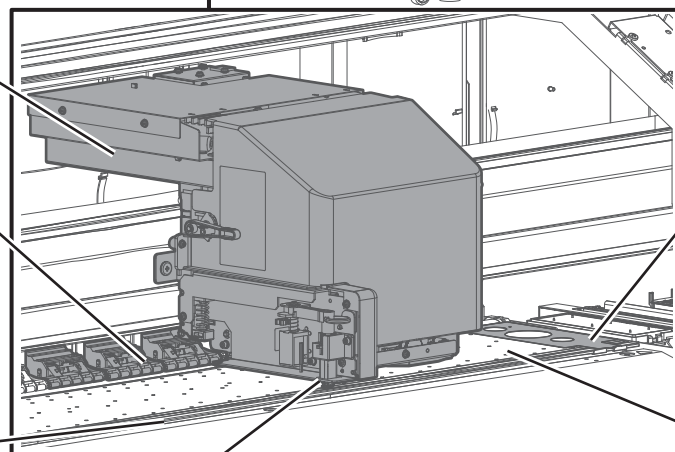
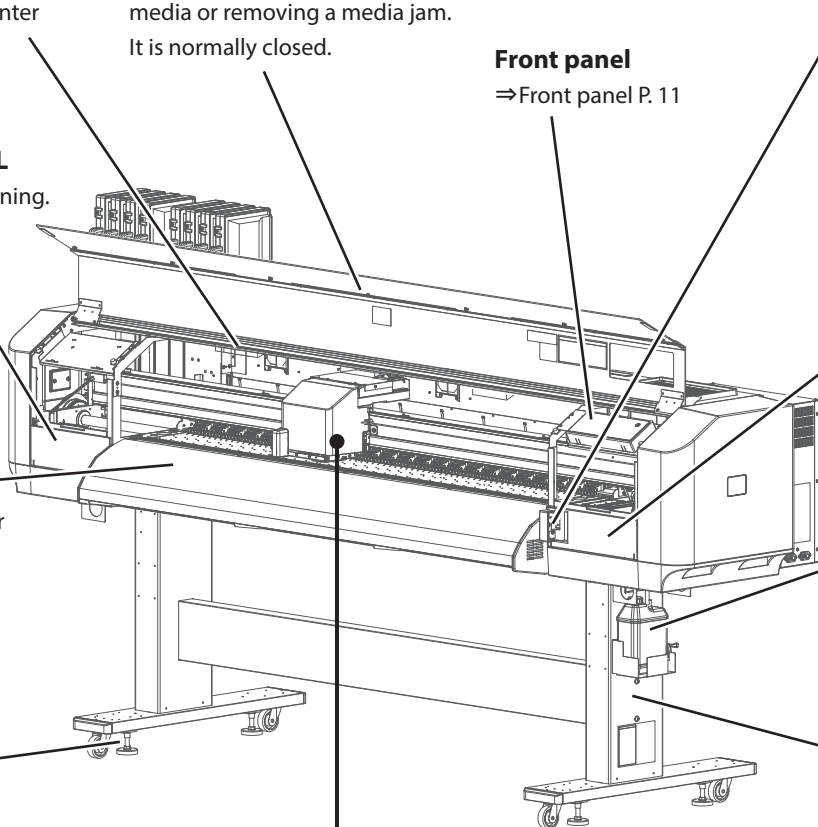

## Rear side

### Media feed lever

Hold down or release the media. This lever is interlocked with the media feed lever on the front side.

### Exhaust fan

Remove exhaust from inside the printer.

### Ink slots

Insert an ink bag case into the slot.

### Media guide

Pass a roll media through the media guide.

### Roll media holder

Attach the media flanges to both ends of a roll media and load it onto the roll media holder.

### Network interface cable connector

### AC inlet

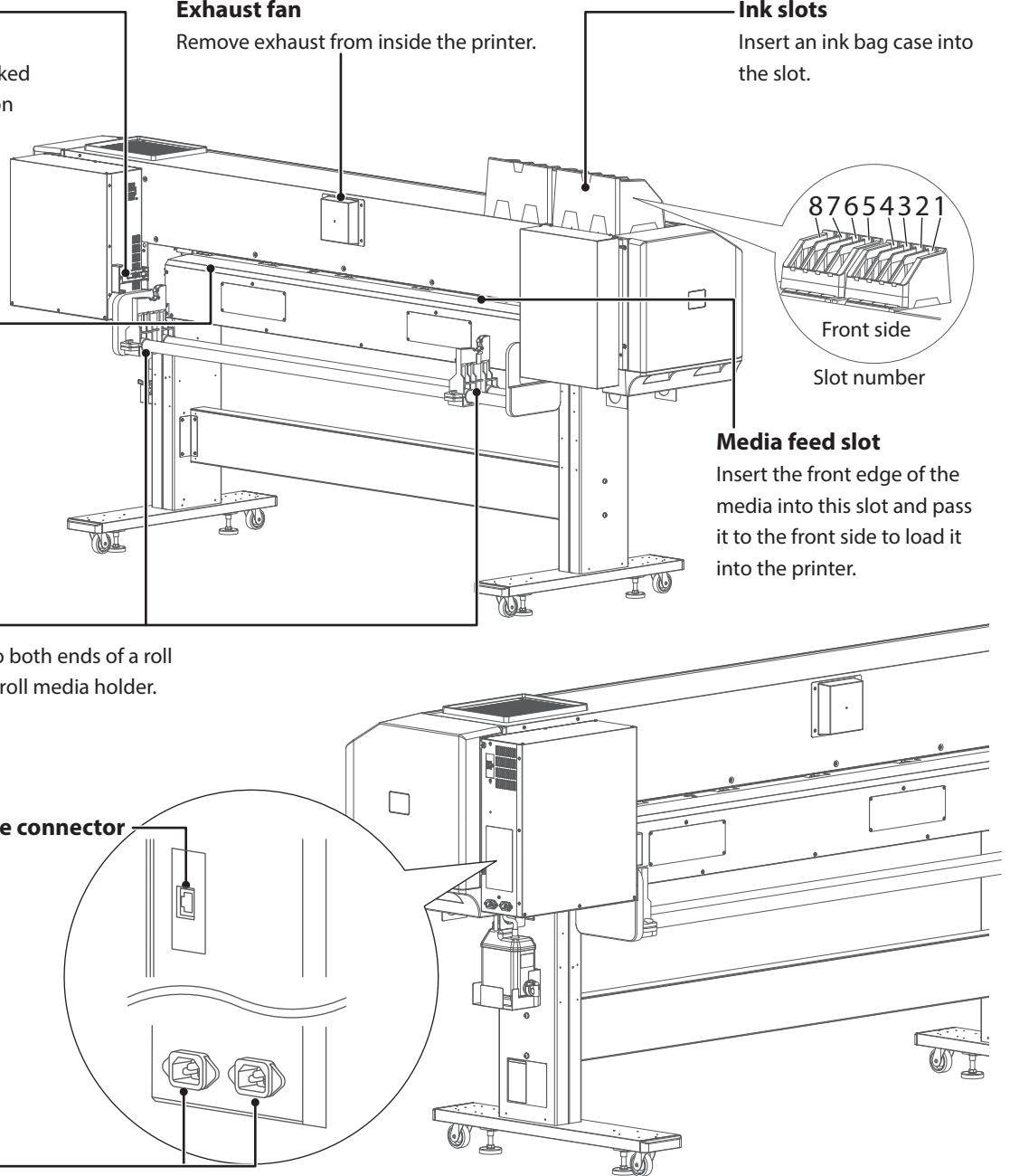

## Front panel

The printer has a touch-screen panel located on the front right of the printer. The active keys are lit up on the panel for guidance.

- Tap: Lightly touch the key with your finger, then immediately release.
- Long-touch: Keep touching the key.

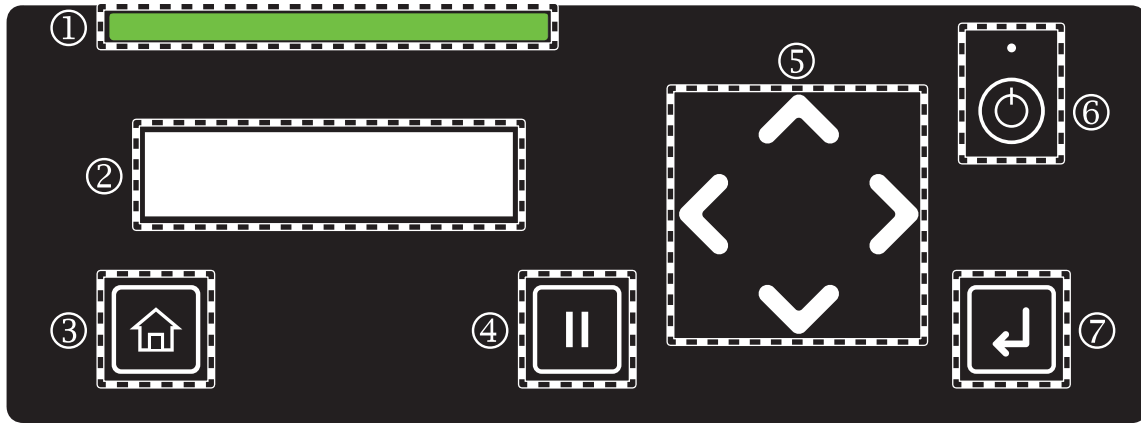

1 Status Bar

Indicates the printer status by LED light.

- Working normally: Solid green
- Error/Alert state: Solid red (error) or flash red (alert)

2 Display

Displays the printer status, setting menu, errors and so on.

3



[Home] key:

Access to or exit the menu.

4



[Cancel] key:





- Pause the print job. While pausing, tap the key again to resume printing.
- While the printer is not printing, tap the key to cut the media.
- (Requiring the optional drop sensor unit)  
While the auto nozzle checking, tap the key to cancel the auto nozzle check.

5







Arrow keys:

When you have entered the setup menu, the arrow keys are used to select a menu or enter a value.

-  key: Go to the previous item.
-  key: Return to the upper level menu without saving the change.
-  key: Go to the sub menu.
-  key: Go to the next item.

While the printer is in standby mode, it is used to feed media, run a nozzle check, or perform head cleaning.

-  key: Feed the media backward. Long-touch to feed it with high speed.
-  key: Tap to run a nozzle check F.
-  key: Tap to perform cleaning.
-  key: Feed the media forward. Long-touch to feed it with high speed.

6



[Power] button:

- Pressing the button for more than 2 seconds while the power is off will turn on the power. The small LED above the button will turn on white.
- Pressing the button for more than 2 seconds while the power is on will put the printer in sleep mode. The small LED above the button remains on white.
- Normally use the setup menu on the control panel to turn off the power. The LED above the power button turns off when the power is off.

 ["Turning the power OFF" P. 24](#)



**Note**

The  symbol means "standby". Even the Power LED turns off, the device still consumes some power unless the power cords are disconnected. This state is referred to as the power being "off" in this Manual.

7



[Enter] key:

Use the Enter key to select a menu or confirm a value.

- While the printer warms up, tap the Enter key to start printing immediately before fully warming up.

## Connecting to a Computer

### Important!

Make sure your computer meets the following requirements.

- **OS:** Windows 11
- **CPU:** Intel (R) Core (TM) i5 or more
- **Memory:** 8GB minimum
- **Network:**  
Use a network port that supports Gigabit Ethernet, and an Ethernet cable that supports Category 6 Gigabit Ethernet or later.

### Note

- The OS support period of MUTOH software follows the Microsoft support lifecycle policies.
- When using RIP software, please also see the system requirements of your RIP software.

- [1] Connect the Gigabit Ethernet cable to the printer.

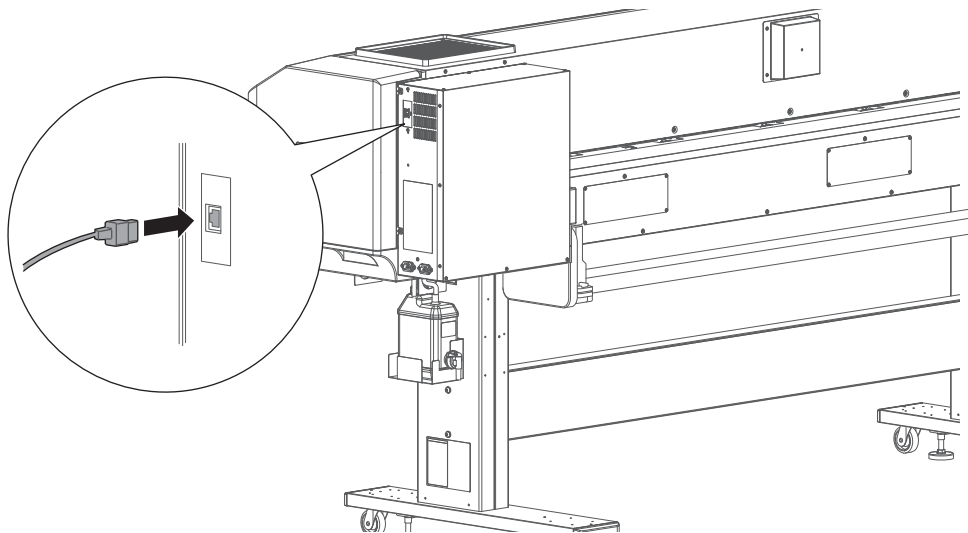

- [2] Insert the tip of the cable tie into the hole on the printer to attach it.

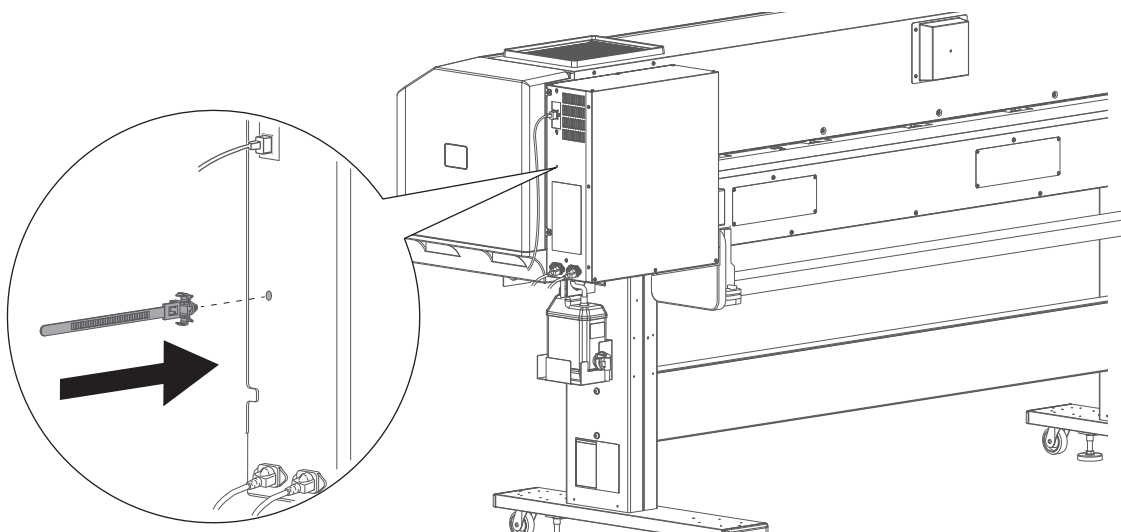

- [3] Use the cable tie to secure the Ethernet cable to the printer.

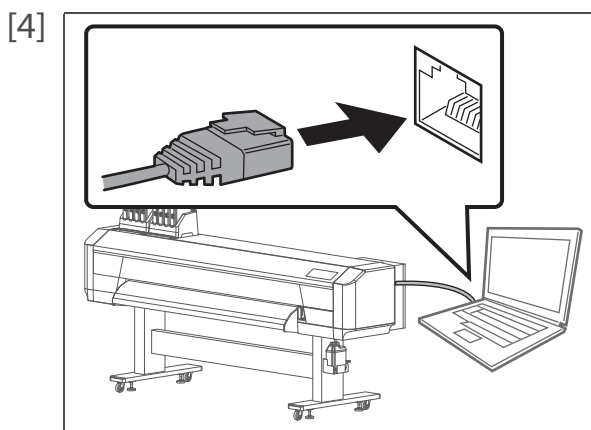
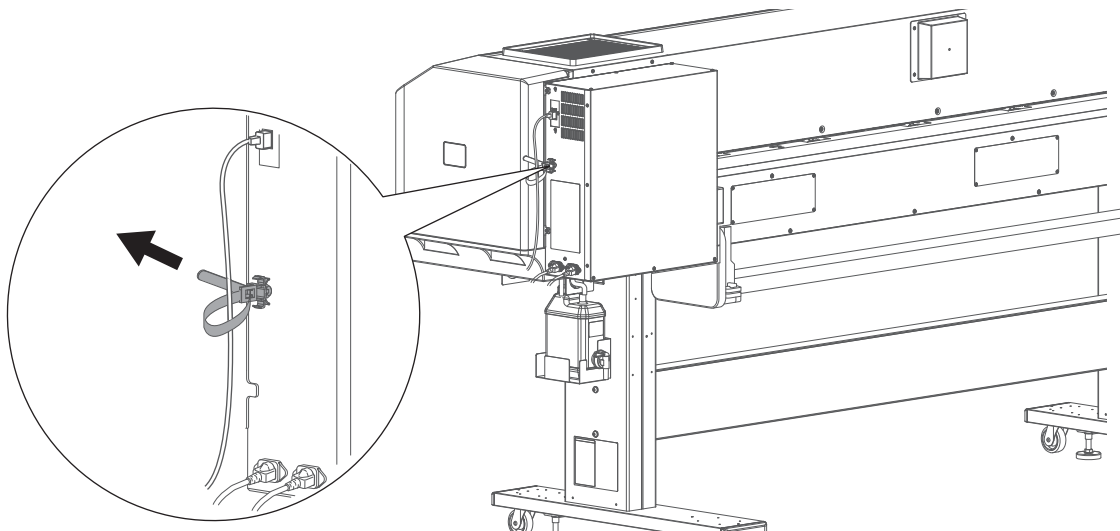

- Connect the Gigabit Ethernet cable to the computer.

- [5] Use the front panel on the printer to assign the IP address, subnet mask and gateway.

 ["Initial Settings 4: IP Address" P. 123](#), ["Initial Settings 5: Subnet Mask" P. 123](#), ["Initial Settings 6: Gateway" P. 124](#)

 **Note**

- The illustration above shows the peer-to-peer connection between this product and computer.
- If you are using the LAN connection, make sure that your printer and computer are on the same subnet.

## System configurations of this product

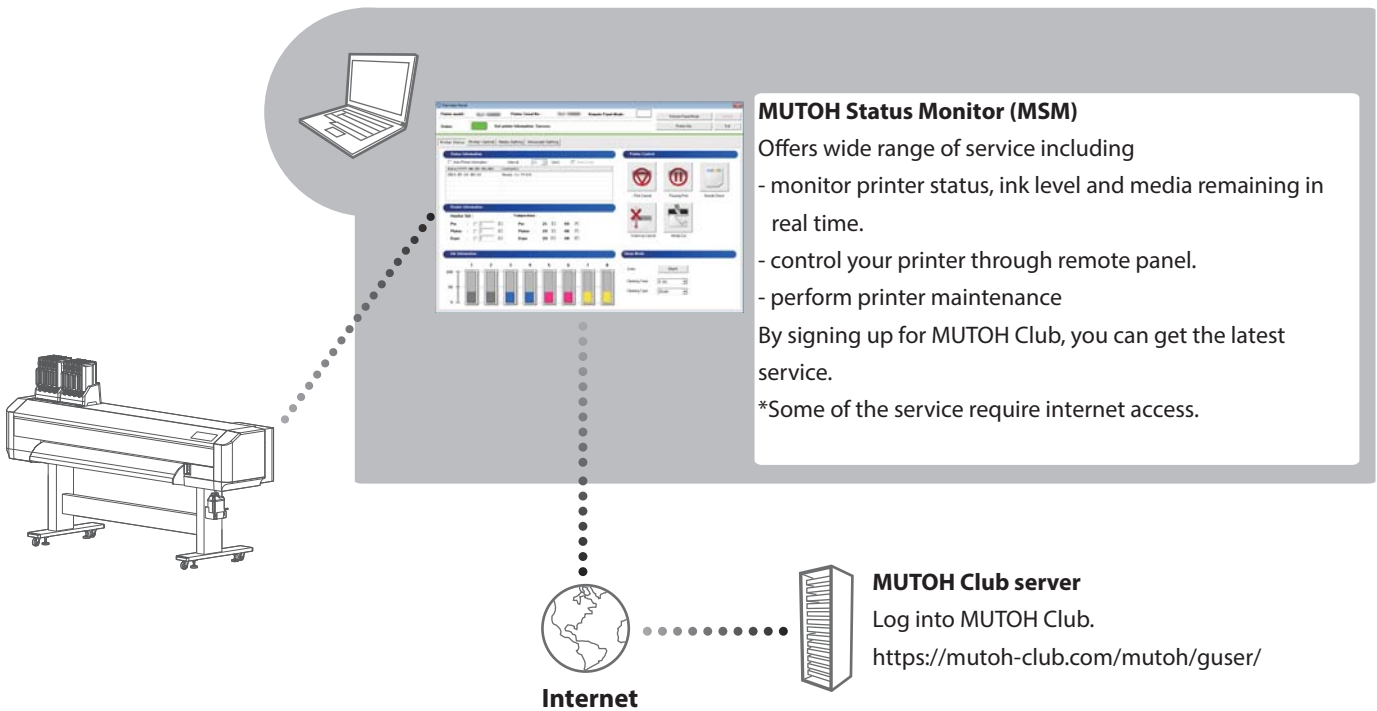

### \*1 MUTOH Club

By signing up for MUTOH Club, it offers free useful contents including

- download the latest version of application, operation manual
- download media profile
- check printer information  
(printer information uploaded through MSM can be viewed)

### <Print Support Software>

To get the best out of this product, use the MUTOH Status Monitor (MSM).  
You can download the latest version of MSM from the MUTOH Club Server.  
(To use MPS, specify the output port of RIP software to MPS.)

## Launching/Displaying/Exiting MUTOH Status Monitor (MSM)

### Launching MSM

---



#### Windows 11

Double click the MSM icon on the Desktop.



#### Note

Launching from the Start Menu of Windows

From the [Start] menu, click [All Programs] (or [All Apps]) - [MUTOH] - [MUTOH Status Monitor].

### Displaying MSM

---

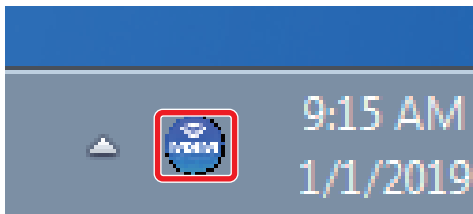

Double click the MSM icon in the task tray.

## Displaying remote panel

---

The remote panel allows you to view the printer status or remotely operate your printer.

Click [Remote Panel].

- The remote panel opens.

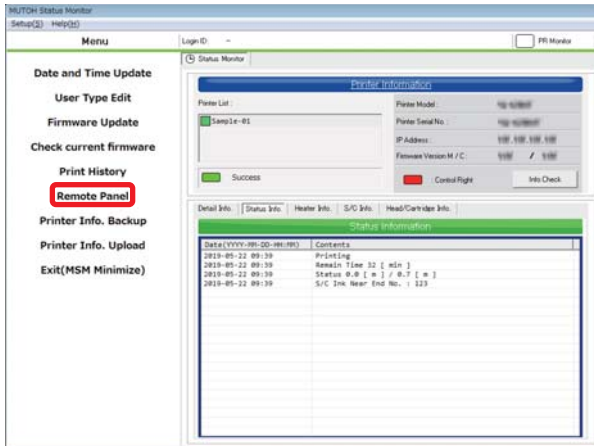

## Exiting MSM

---

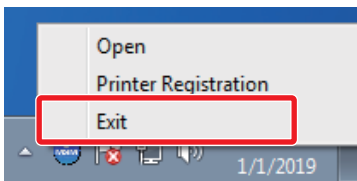

Right click the MSM icon in the task tray, and click [Exit].

### Note

While using your printer, do not exit MSM. To close the MSM window, click [Settings] - [Close].

## Printing area

Printing is always started from Origin position (print start point) with following margin on all sides of a page as shown here.

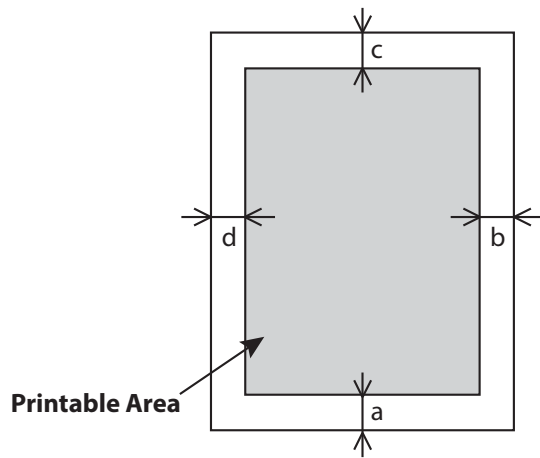

a=5 mm \*<sup>1</sup>  
b=5 mm to 25 mm \*<sup>2</sup>  
c=5 mm  
d=5 mm to 25 mm \*<sup>2</sup>

\*<sup>1</sup> The value of "a" will be 15 mm in the following cases:

- Immediately after media initialization
- When feeding the media backward by using 

The value of "a" will be 40 mm in the following cases:

- When Media Initial menu is set to "Top&Width"
- After cutting the media

\*<sup>2</sup> Margin can be changed from the Side Margin menu.

## Media size

Media that meet the requirements below can be used on this printer.

|                             |  |
|-----------------------------|--|
| Roll media diameter         | 200 mm maximum   |
| Media core diameter         | 2 inches: 50 mm to 52 mm<br>3 inches: 75.5 mm to 79 mm |
| Weight                      | 30 kg or less  |
| Width                       | 500 mm to 1,625 mm                                     |
| Recommended media thickness | 1.0 mm or less   |

### Important!

- The default head height is set to "Low1".  
In the "Low1" setting, media up to 0.3 mm thick can be loaded on the printer.

### Note

Contact your local MUTOH dealer about roll media recommended for your printer.

## Cautions on handling media

---

Note the following points when handling the media.

- Use the media under an appropriate environment.  
The appropriate temperature and humidity for printing are as follows.

|                                  |   |
|----------------------------------|---|
| Recommended Printing Environment | Temperature 22 to 30 °C<br>Humidity 40 to 60%, No condensation                    |
| Change rate                      | Temperature: No more than 2 °C per 1 hour<br>Humidity: No more than 5% per 1 hour |

- Do not use media which is folded, cut, or torn.
- The size of media can change according to changes in humidity in the printing environment.  
Before using media, leave media for 1 hour in the printing environment to adapt it to the environment.  
Performing printing without adapting media to the printing environment may cause media jams due to gaps or wrinkles in the media. Print quality is also affected.
- When using the printer in a low-humidity environment, the cut media may stuck and may not come down. In such a case, open the front cover after the media is cut to remove the media.
- Do not touch the print side.  
Moisture and oil on your hands may affect the print quality.
- Do not leave media set in the printer for a long time.  
Some media has a tendency to bend, causing media jams and degradation of print quality.  
Avoid using such media especially in winter, in dry conditions, and when printing formal documents.
- Do not discard the individual box and bag. Use them for storing media.

## Precaution on storing media after use

---

When storing roll media after use, follow these precautions to avoid print defects caused by cockling.

- After removing your roll media from the scroller, wind it back onto the roll properly and put it in the original plastic bag. Then store it in the package it came in.
- Avoid high temperature, high humidity, and direct sunlight when storing media.
- Keep the media dry.

## Precautions

### Please use this product at least once a week

---

If the printer is not used for a long time, the print head nozzles can get clogged causing damage to the printer.

### Please handle ink bag carefully

---

- Before using an ink bag, make sure to read the Safety Data Sheet (SDS).
- Do not disassemble Ink bag.  
Ink may come into contact with your eyes or skin, causing irritation or allergic reaction.
- Wear protective gloves, glasses, and mask when handling ink bags.
- Avoid contact with your eyes or on your skin.  
If in your eye or on your skin, immediately wash with water.  
It could cause bloodshot eyes or light inflammation. Should any anomalies occur, immediately seek medical attention.
- DO NOT drop or hit an ink bag.  
Ink may leak from the bag.
- Be sure to use the ink before it expires.  
The expired ink should be disposed of as industrial waste. The empty ink bag should be put in a plastic bag and should be disposed of according to the local regulations.
- MUTOH strongly recommends to use genuine ink.  
This printer is designed to bring out the best performance when using with the MUTOH genuine ink.  
Non-MUTOH ink may cause print defects or damage to the printer.

### Conduct periodic maintenance

---

This product requires regular user maintenance.

- Run a nozzle check before and after printing.  
If nozzle clogging is found, run a head cleaning.
- Clean the cleaning wiper, around the capping unit, and the print head circumference once a week.
- If you are not using the printer for an extended period\*, run a head cleaning once a week.  
If you cannot perform weekly head cleaning, then perform [Longstore] (👉 ["Long-term storage" P. 169](#)).  
\*"Extended period" means one to four weeks.
- Clean inside of your printer once a month.
- Regularly check the waste ink tank and empty the tank as needed.

### Some parts need to be replaced periodically

---

In this product, there are some parts required to be replaced after a long-term use.

- User replaceable parts: Absorption material for the flushing box, Cutter, Cleaning wiper
- Parts required to be replaced by service personnel: Motors, Pumps, Print heads

## Turning the power ON

[1] Close the front cover.

[2]

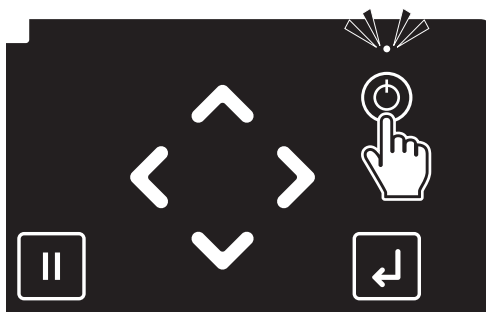

Long press the Power button.

- The Power LED (above the Power button) lights up.
- The printer will start mechanical initialization.

 **Note**

Once the Power LED lights up, release the Power button.

## Sleep Mode

This printer must be powered on all the time. While not in use, put it into sleep mode. Putting into sleep mode while not in use will minimize the chance of coagulation of the ink inside the printer. While in sleep mode, the printer performs automatic head cleaning regularly. The LED above the power button lights up and key operation is invalid except  (Enter).

When you need to turn off the printer for maintenance, operation from the setup menu on the control panel.

 ["Turning the power OFF" P. 24](#)

### Start the sleep mode

[1] Ensure that printing is complete and media has been removed.

[2]

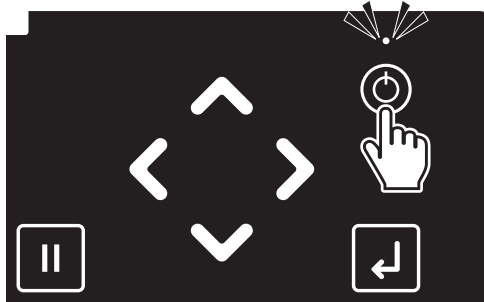

Press the power button on the control panel for more than two seconds.

- [Please wait] appears.

[3]



When the message on the left appears and the printer starts sleep mode.



Sleep mode cannot be entered in the following cases:

- Errors are occurring (Ink End, No Bag, Full Waste Ink Tank, Cover Open, etc.)
- Printer is running ( during Media Initial, printing, etc.)

When unable to start sleep mode

- [Clear the error] appears: Clear the error that is being displayed and then put it into sleep mode.

 ["Error message display and remedies" P. 180](#)



- [Unable to Enter to Sleep Mode] appears: The printer is in operation. After the printer has finished its operation, put it into sleep mode.

### Important!

**If any of the following conditions occur during sleep mode, head cleaning will not be executed (operation will be stopped during head cleaning). When restored to normal conditions, head cleaning will resume.**



- **Front cover or maintenance cover is open.**
- **The pressure rollers are in up position.**
- **Waste ink tank is full.**
- **Ink bag case is removed.**
- **Smart chip card is removed.**
- **A non-genuine smart chip card is inserted.**

 Note

- You can also put the printer into sleep mode from the setup menu of the printer control panel. Change the type and interval of automatic head cleaning to be performed during sleep mode from the setup menu of the printer control panel.  
 ["Sleep Mode 1: Cleaning Setting" P. 120](#)
- The printer is automatically put into sleep mode if no printing is performed for certain period. You can change the timer to automatically enter to sleep mode using the setup menu on the control panel, but we suggest to use the default setting 4 hours.  
 ["Sleep Mode 2: Auto Sleep Timer" P. 120](#)

## Wake up from sleep mode

---

- [1]  Tap  (Enter).
- The printer wakes up from sleep mode and [Print Ready] appears on the panel.

## Turning the power OFF



Normally use the setup menu on the printer control panel to turn off the printer.

[1] Ensure that printing is complete and media has been removed.

[2]  Tap  (Home).

[3]  Tap .

[4]  Use  to choose the menu shown left.  
• Tap .

[5]  Use  or  to select [Power Off? Yes] and tap  (Enter) to confirm the setting.

- The printer begins powering off.
- The LED above the power button turns off.

### Important!

**In the following cases, pressing the power button for more than 2 seconds will power off the printer.**

- **When an error requiring reboot occurred**
- **Ink has not been filled in the printer**
- **During printer activation**
- **After the printer firmware has been updated in MSM**

[1] Long press the Power button.  
• The printer will start powering off.

[2] When [Power Off] appears, release the Power button.  
• The Power LED lights off.

# Loading a roll media

## Important!

Depending on the size of media, two or more people are required.

## Load a roll media into the printer

### 1. Attach flanges to the media

#### Items Required:

- Roll media
- Media flange: x2

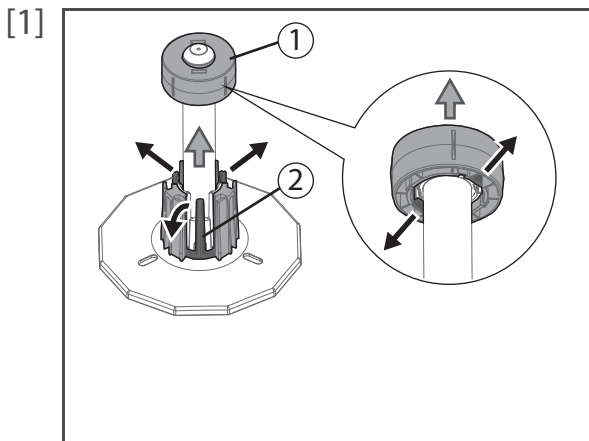

(If you are using 2-inch core roll media) Remove the 3-inch adapters from the media flange.

- ①: Pull two tabs on the adapter outward, then remove it from the flange.
- ②: Pull three tabs on the adapter outward, then remove it from the flange.

#### Note

- If ② adaptor cannot be removed, turn the handle on the flange anti-clockwise to loose (see Step 2), then remove it.
- If you are using 3-inch core roll media, skip this step.

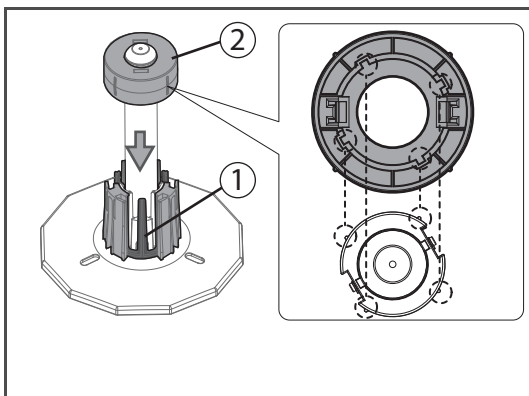

(When replacing 2-inch core roll media with 3-inch core roll media) Attach the 3-inch adapters to the media flange.

- ①: Align the tabs (x3) on the adapter with the dents on the base of flange to click into place.
- ②: Align the notches (x4) on the inside of adapter with the protrusions (x4) on the leading edge of media flange as shown to the left to attach it to the edge of the media flange.

#### Note

- If ② adapter is misaligned, it will not be properly fixed to the media flange.

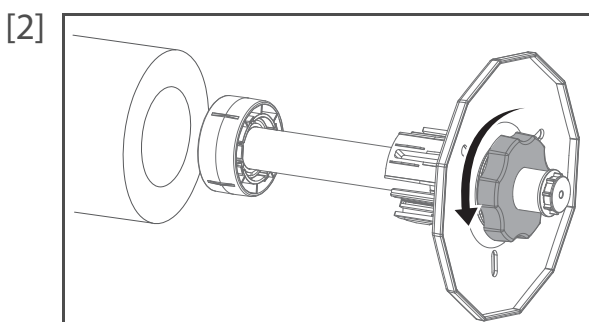

Push the media flange (x2) into the both ends of the media core.

- Before inserting, twist the handle on the flange anticlockwise to unlock it.

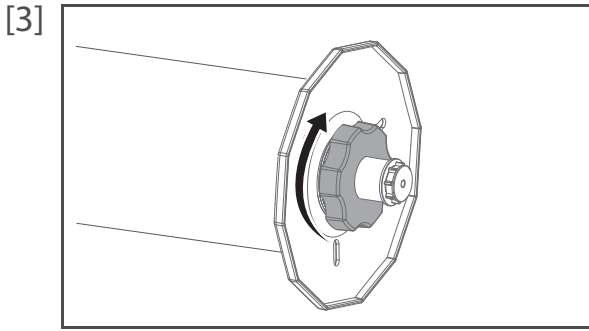

Twist the handle clockwise to lock the flange.



**Check that the flange is firmly locked.  
If not, the media can be removed from the flanges, affecting the print quality.**

## 2. Enable torque on media holders

If you want to apply torque to the media holders, follow the steps below.

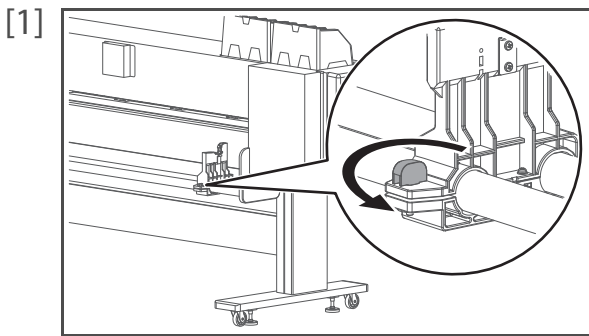

Twist the knob bolt on the right side of the media holder anticlockwise to loosen.

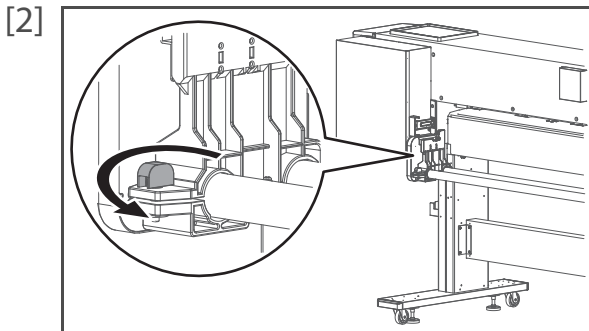

Twist the knob bolt on the left side of the media holder anticlockwise to loosen.

[3] Slide both left and right media holders about 30 cm towards the center of the slider for easy access.

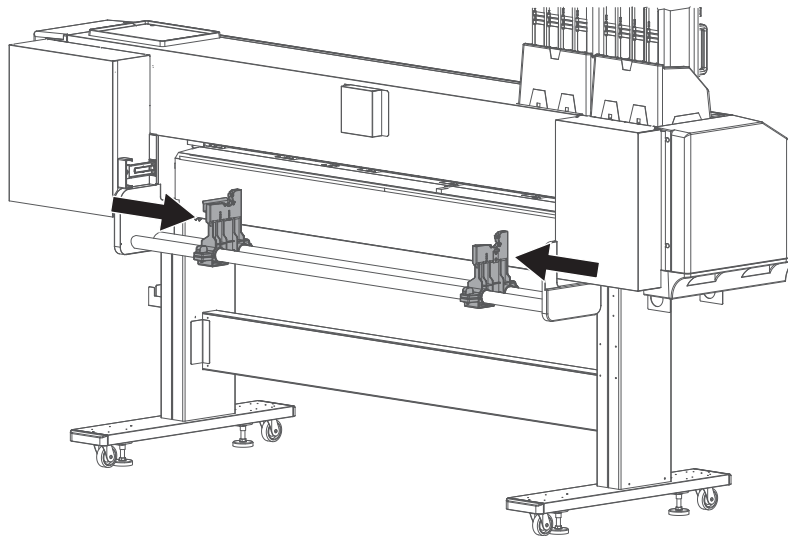

[4] Tighten the knob bolts on both media holders.

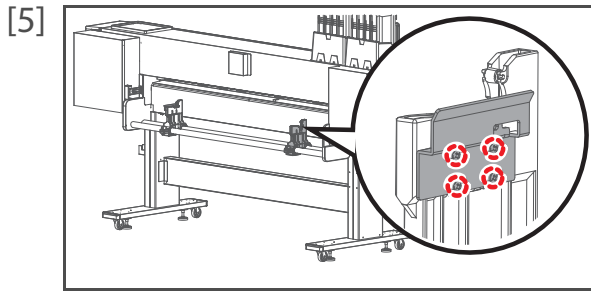

(When looking from the rear side of the printer) Use the screwdriver to loosen four screws securing the roller shaft guide plate to the right media holder.

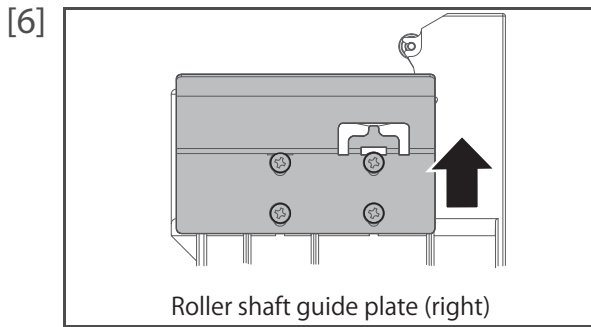

Slide up the roller shaft guide plate as far as it will go and tighten the screws.

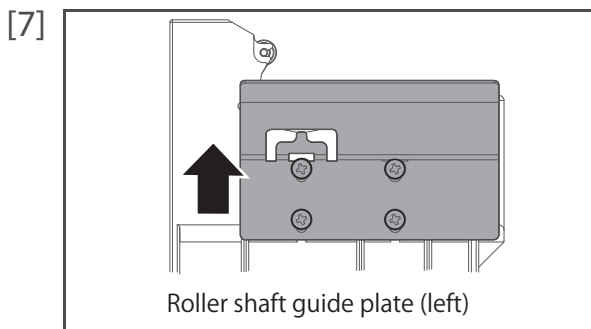

Do the same for the left media holder to slide up the roller shaft guide plate as far as it will go and tighten the screws.

[8] Loosen the knob bolts and slide back both media holders to the original position.

[9] Tighten the knob bolts.

### 3. Place the media onto the media holder

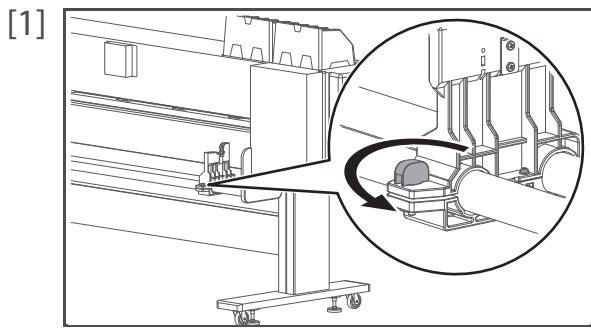

Twist the knob bolt on the right side of the media holder anticlockwise to loosen.

- [2] Place the roll media onto the left media holder. Carefully and gently place it on the holder.
- Place the flange between the roller shaft guide plate and the media holder as shown in the illustration.

 **Important!**

**Do not drop or apply excessive impact while placing the media. This will cause damage to the part.**

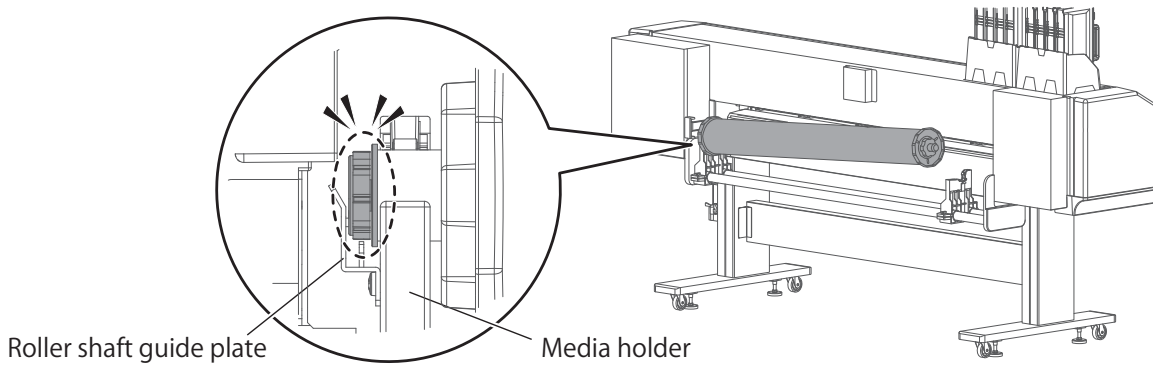

If you set the torque, continue to check the following.

- ①: When looking from the left side, check that the protrusion on the roller shaft guide plate is fitted into between two protrusions on the flange end cap.
- ②: When looking from the rear side of the printer, check that the flange end cap is properly placed on the protrusion on the roller shaft guide plate.

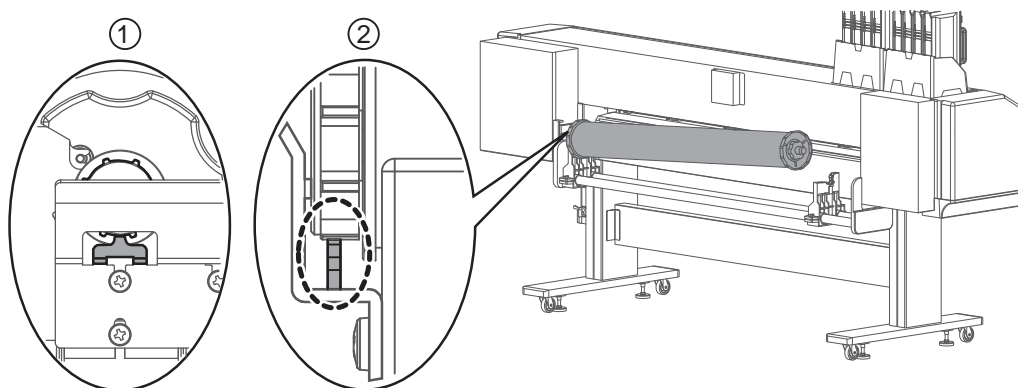

 **Important!**

**When you adjust the position of the media holder (left), do not move it more than 450 mm away from the left-hand end. The printer will not be able to detect media.**

[3] Place the roll media onto the right media holder. Carefully and gently place it on the holder.

- Slide the right side of the media holder to place the right side of the flange onto the holder.
- Place the flange between the roller shaft guide plate and the media holder as shown in the illustration.

 Important!

**Do not drop or apply excessive impact while placing the media. This will cause damage to the part.**

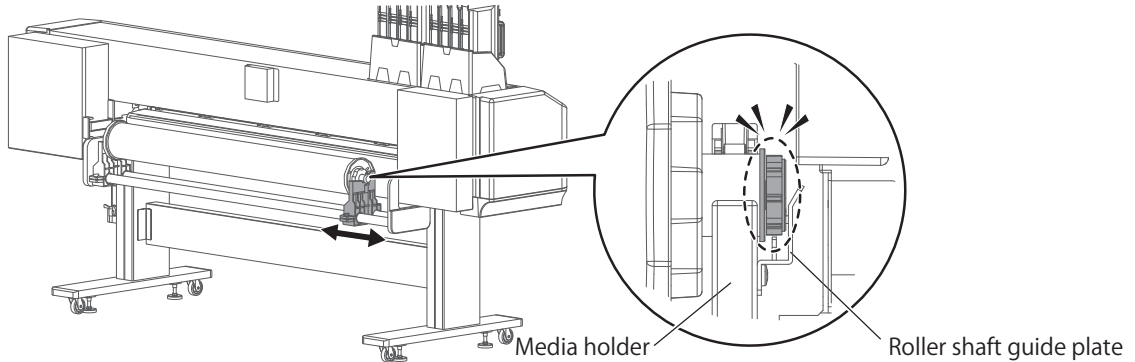

If you set the torque, continue to check the following.

- ①: When looking from the right side, check that the protrusion on the roller shaft guide plate is fitted into between two protrusions on the flange end cap.
- ②: When looking from the rear side of the printer, check that the flange end cap is properly placed on the protrusion on the roller shaft guide plate.

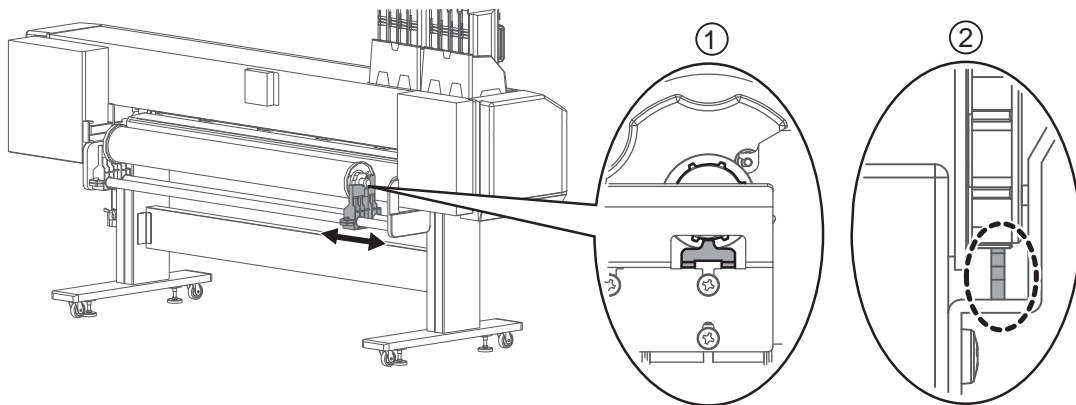

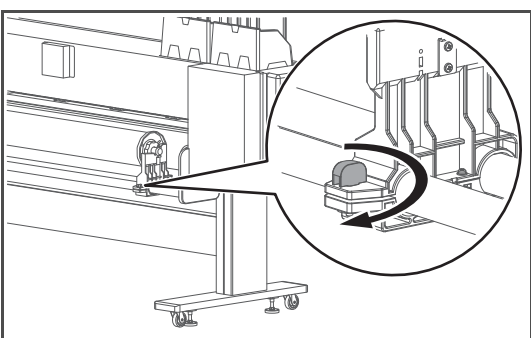
[4]  Twist the knob bolt on the right side of the media holder clockwise to tighten.

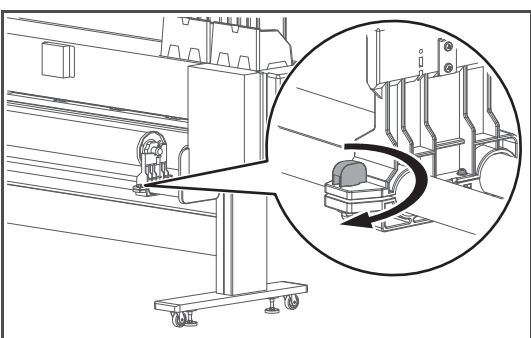

## 4. Load the media into the printer

[1] Check that the printer is powered on.

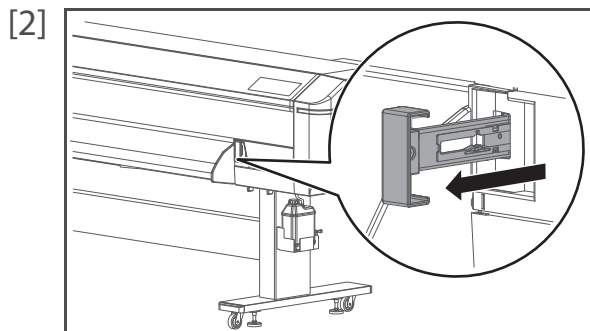

From the front side of the printer, pull the media feed lever towards you as much as possible to release the pressure rollers.

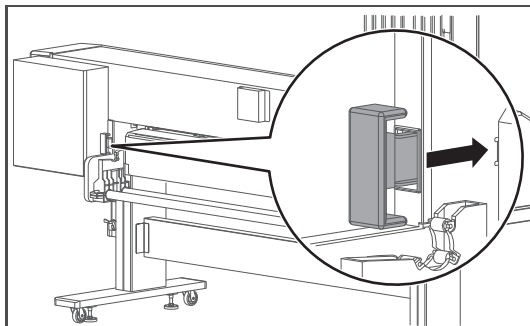

You can access to the media feed lever from the rear side of the printer.

- To release the pressure rollers, push the media feed lever.
- To lock the pressure rollers, pull it towards you.

 **Note**

Using this lever, the holddown pressure can be changed between High and Normal. To apply high pressure, pull the lever towards you as much as possible.

 ["Changing holddown pressure using media feed lever" P. 52](#)

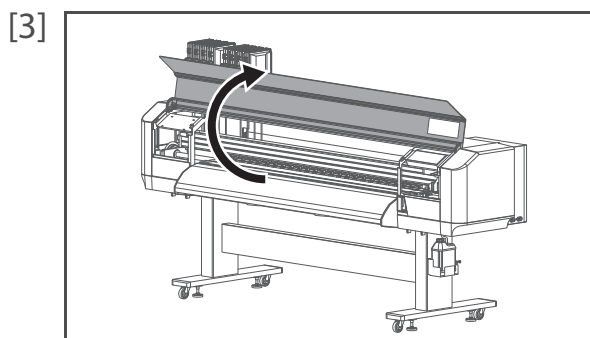

Open the front cover.

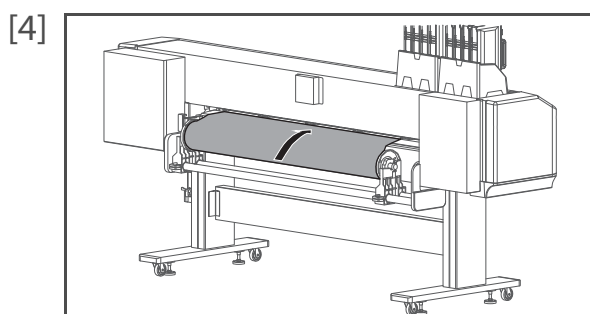

From the rear side of the printer, insert the front edge of the media into the media slot.

 **Note**

Before inserting, rewind the media properly.

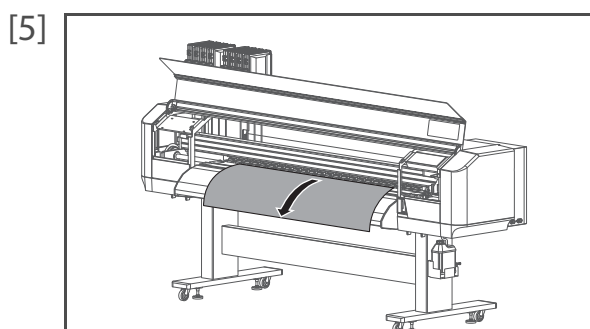

From the front side of the printer, pull the media for approximately 1 m.

- [6] While one person holds the front edge of the media, the other person turns the flange to slightly rewind the media onto the roll to remove warp or skew.

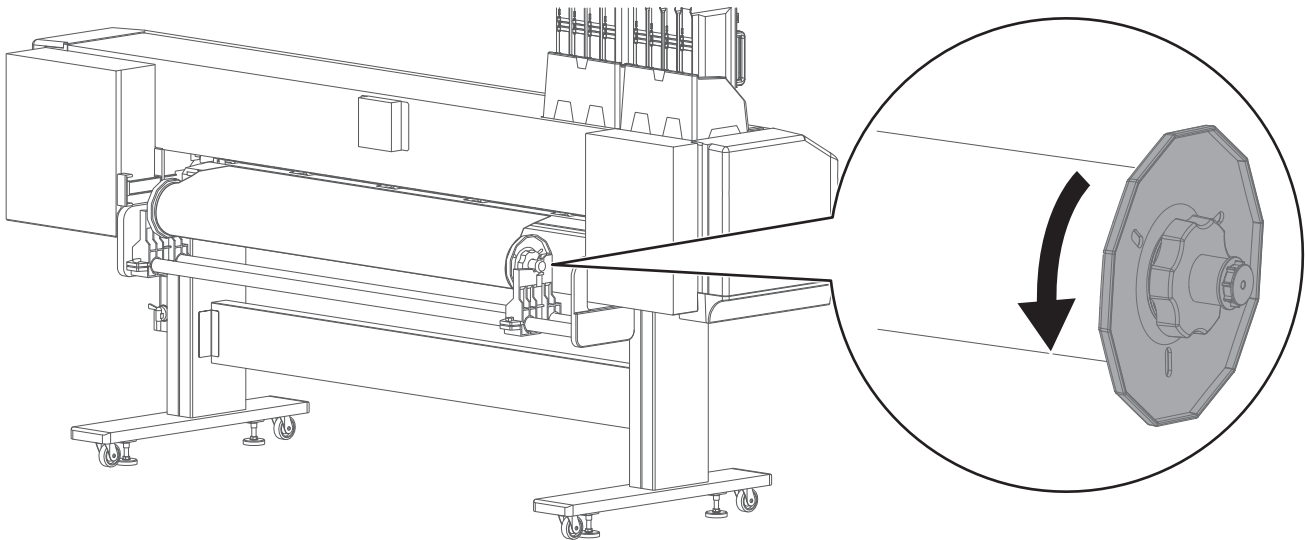

 Note

If you remove your hands from the front edge of the media while rewinding, the media can be removed from the media slot.

- [7] Check that the right-hand edge of the media is located at the left side of the media guide line.  
If not, print quality can be affected.

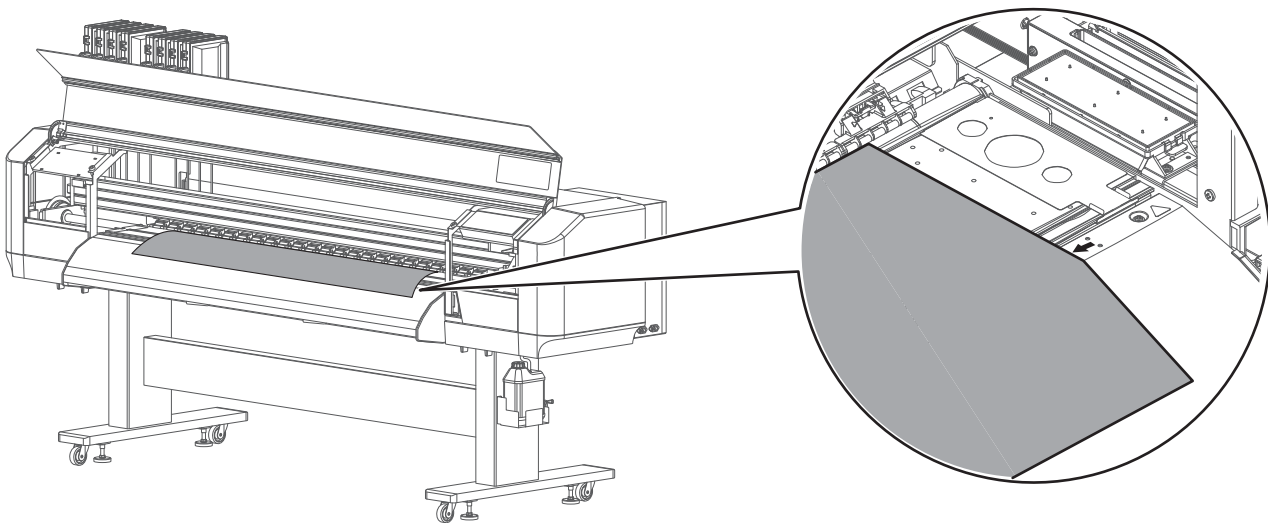

- [8] If needed, use a slide lock lever on the pressure rollers to individually cancel or reduce the holddown pressure.  
 ["Canceling or reducing pressure rollers individually" P. 53](#)

 Note

Normally you do not need to adjust the holddown pressure by the slide lock levers.  
To print on thin or soft media, individually reduce the holddown pressure.

## 5. After loading the media...

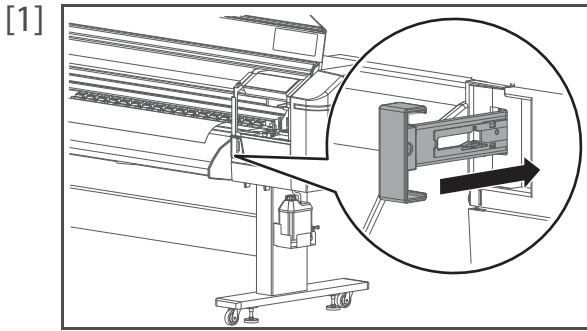

From the front side of the printer, push the media feed lever to hold the media flat with pressure rollers.

**Note**

Using this lever, the holddown pressure can be changed between High and Normal. Normally push the lever until it clicks to apply normal pressure.

["Changing holddown pressure using media feed lever" P. 52](#)

- [2] Check that the pressure rollers hold down the both edges of the media properly.
- If it holds as a "No Good" example, pull the media feed lever towards you as much as possible, then adjust the position of the left or right side of the media holder until the both edges of the media are held down properly (see ["Load the media into the printer" P. 30](#) for more details).

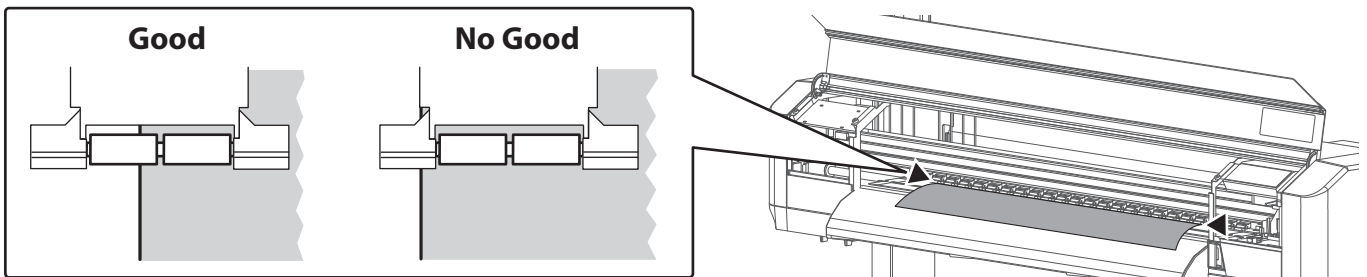

- [3] Place the edge holders on both edges of the media.
- Lift up the tab on the front of edge holder so that the center of edge holder is lifted. Move and place it on the edge of the media while the center of the edge holder is lifted.

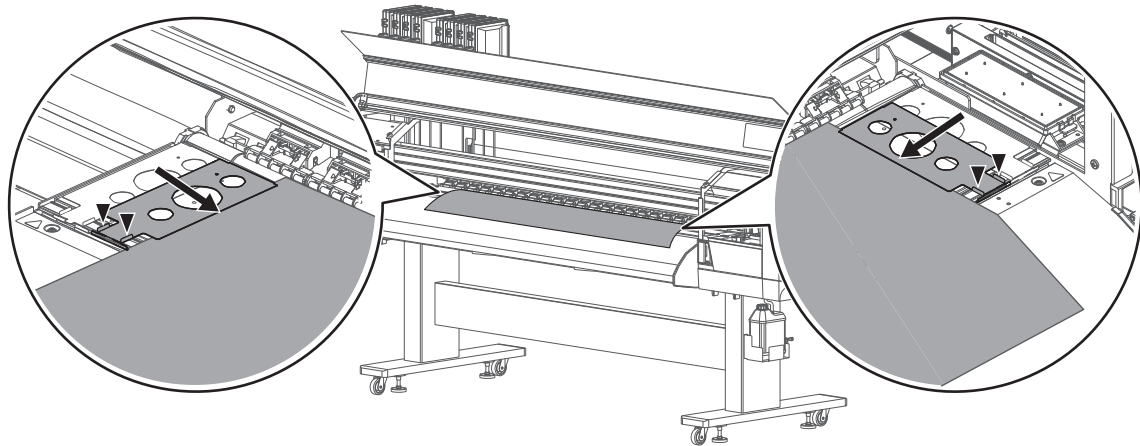

 **Note**

The way to attach edge holders varies depending on type of roll media to be loaded.

 **"Swapping left and right edge holders depending on the media type" P. 51**

- Normally attach them as shown in the figure below so that the hole on the edge holder is located on the outside of the holder. This will hold down roll media lightly.



- To print on thin or soft media, swap left and right edge holders and attach them as shown in the figure below so that the hole on the edge holder is located on the inside of the holder. This will hold down wider area on roll media.



 **Important!**

**In the default setting, the printer starts printing with 5 mm margin on the sides. Set the side margin to 10mm or more according to the following procedure because the overlapping part of the edge holder and media may be stained with ink.**

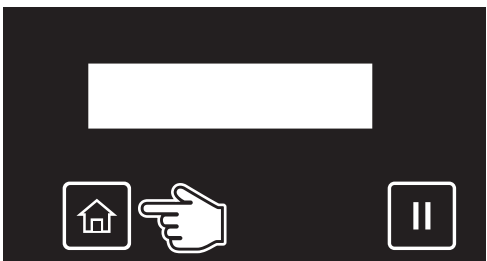
[4]  Tap  (Home).



[5]  Tap .

[6]  Use  to choose the menu shown left.  
• Tap .

[7]

Side Margin :  
(5 - 25) 10 mm

Enter the side margin. At least 10 mm margin is required.

- Use  or  to enter the value.
- Tap  (Enter) to confirm the setting.



Note

The side margin can be set between 5 mm and 25 mm.

[8]

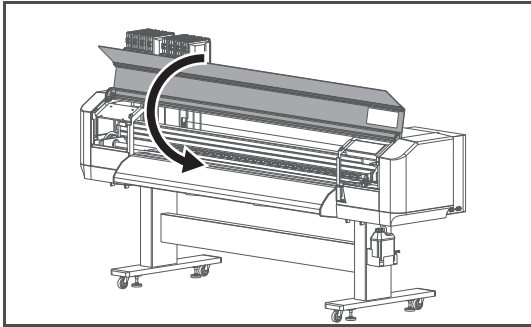

Close the front cover.

[9]

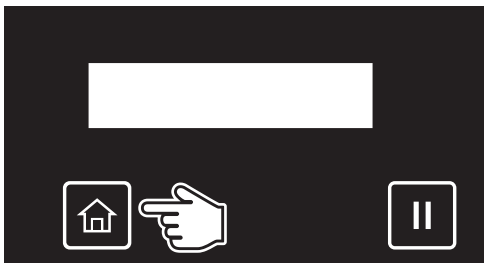



Tap  (Home).

[10]

User:  
Type 1 OK?



"User: Type\*\* OK?" appears on the touch panel.

- Use  or  to choose the correct user type and tap  (Enter) to start media initialization.  
End the media loading.

# Nozzle check and cleaning

Before you start daily printer operation, run a nozzle check. If nozzle clogging is found, perform cleaning.

This printer offers the following 3 kinds of nozzle checks:

- Nozzle Check: Print a nozzle check pattern selected from " [Setup 20: Head Select](#)" and " [Setup 21: Select Nozzle](#)".  
 ["Nozzle check steps" P. 37](#)
- Nozzle Check F: Print a nozzle check pattern using all of the nozzles on the print head.  
 ["Nozzle check F steps" P. 36](#)
- Auto Nozzle Check (Requiring the optional drop sensor unit):  
Using the built-in drop sensor, the printer runs an automatic nozzle check regularly without consuming your media. If any nozzle clogs were detected, it will perform an automatic cleaning and will continue printing or will automatically select a print head and/or a nozzle segment that works properly to continue printing.  
 ["Setup 26: Auto Nozzle Check \(Requiring the optional drop sensor unit\)" P. 105](#), Drop Sensor Unit Operation Manual

## Nozzle check

### Nozzle check F steps

[1] Load a roll media for Nozzle check.

 ["Loading a roll media" P. 25](#)

[2]

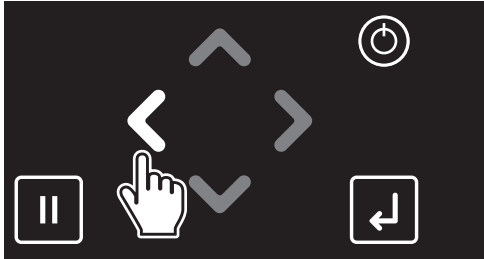

Tap .

[3]



Tap  (Enter).

- The printer will print the nozzle check pattern.

[4]

Check the nozzle check print to see all nozzles are clear.

- If you find missing or thin lines on the print, go to ["Cleaning steps" P. 38](#).
- If all lines are clearly printed, you can start printing.

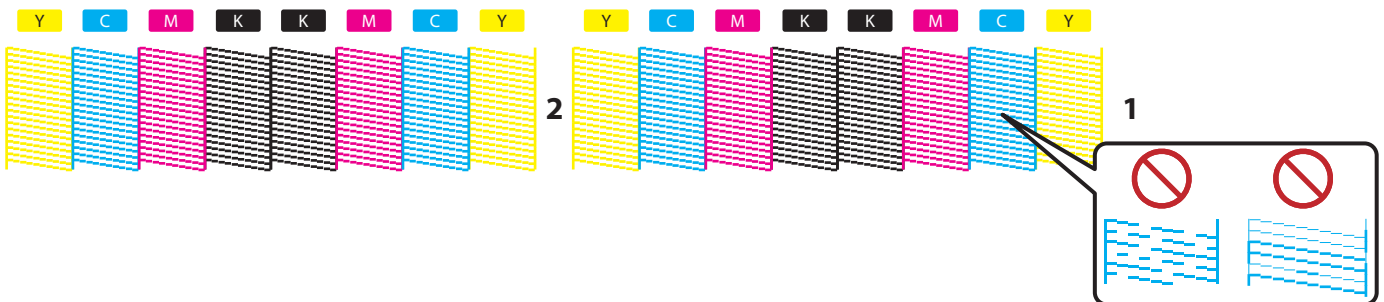

#### Note

- The pattern shown above is an example when printed with 4-color configuration.
- The printer information (date and time printed, printer's serial number, firmware version) is printed on the nozzle check pattern.

## Nozzle check steps

[1] Load a roll media for Nozzle check.

 ["Loading a roll media" P. 25](#)

[2]  Tap  (Home).

[3] 

- Use  to choose the menu shown left.
- Tap .

[4] 

- Tap  (Enter).

[5] Check the nozzle check print to see all nozzles are clear.

- If you find missing or thin lines on the print, go to ["Cleaning steps" P. 38](#).
- If all lines are clearly printed, you can start printing.

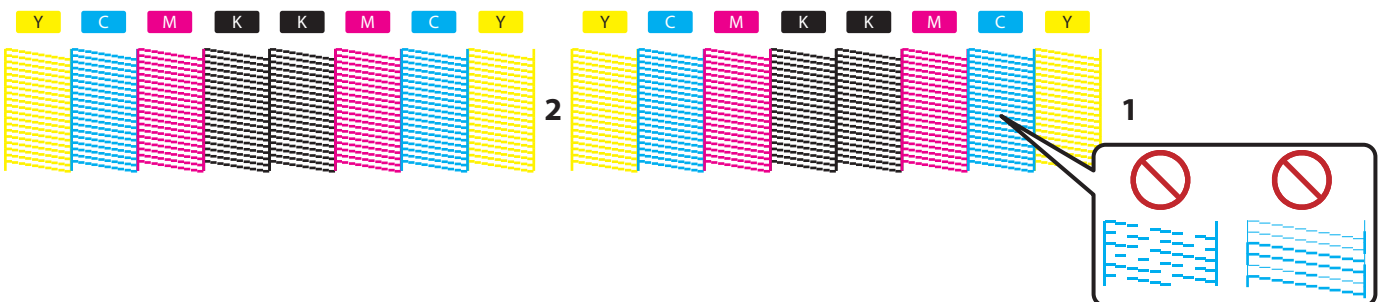

### Note

- The pattern shown above is an example of 4-color configuration printer with Head Select set to "Off", Nozzle Area Select set to "Nozzle ALL" and Select Nozzle set to "Nozzle All".
- For details of Head Select and Select Nozzle menus, see ["Setup 20: Head Select" P. 100](#) and ["Setup 21: Select Nozzle" P. 101](#).
- The printer information (date and time printed, printer's serial number, firmware version, Head Select setting, Select Nozzle setting) is printed on the nozzle check pattern.

# Cleaning

## Cleaning steps

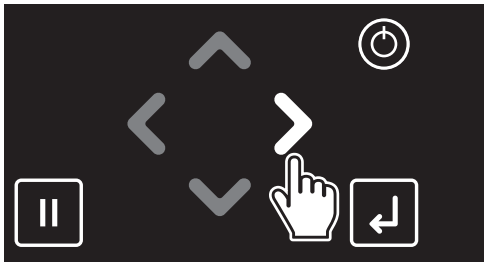

[1]

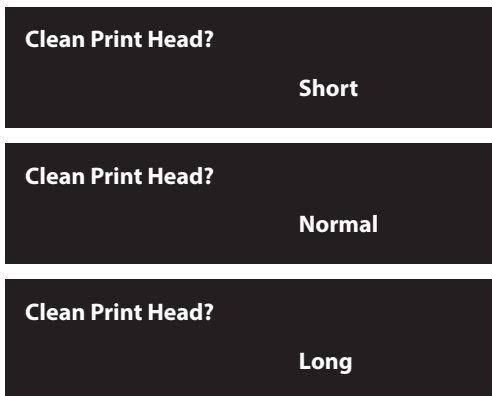

Tap .

[2]



Use  or  to choose the cleaning mode.

Tap  (Enter).

- The printer will start cleaning.

[3]

Run a nozzle check again.

 ["Nozzle check" P. 36](#)

- If the problem persists, repeat normal cleaning until all nozzles are clear.  
See ["Head cleaning" P. 147](#) for the cleaning mode.

### Note

If "Long" or "Little Charge" cleaning does not help to recover the nozzles, go to ["Setup 21: Select Nozzle" P. 101](#) to select the nozzles that fire properly.

# Calibrating your printer

Before printing an image on your printer for the first time, follow these steps to calibrate your printer to ensure accurate print quality.

## Head alignment

You can print out the adjustment pattern in this menu to check the misalignment of the print head, and then adjust it.

You can choose one of the following methods:

### Adjust Head 1

Standard

The Standard option performs the head alignment for the print mode saved in the currently selected user type.

When you use this option, make sure that the resolution, number of pass, and printing direction of the print mode on your RIP is the same as the print mode saved in the user type currently selected.

### Adjust Head 2

Custom

Allows you to adjust also a print mode other than the print mode used by the current user definition.

This method optimizes print quality even if the print mode on the RIP side is different from the user-defined mode.

### Adjust Head 3

Auto

Perform the automatic adjustment using the embedded color sensor.

Allows you to adjust also a print mode other than the print mode used by the current user definition.

This method optimizes print quality even if the print mode on the RIP side is different from the user-defined mode.

### Note

- If you experience following problems, the head alignment can help to improve print quality:
  - Suffering from poor print quality in unidirectional printing mode.
    - 👉 ["Details of print mode" P. 74](#)
  - Print quality does not improve even after performing print quality adjustment
- After you have performed head adjustment, make sure you perform print quality calibration. There may be misalignment caused by head adjustment.
  - 👉 ["Print quality calibration" P. 41](#)
- If you change the print mode after performing the Standard head alignment, you need to perform the head alignment for the print mode chosen.
- Since all print modes are adjusted at once after performing Custom head adjustment, head adjustment is not required even after changing the print mode.
- When specifying a print mode for RIP software, etc, that is different from the mode set in the user type setting, perform Custom head adjustment and check all patterns (A to F), and then adjust any patterns that are misaligned beforehand.
- If print defects (like banding or grainy look) still appear on the print, try an auto calibration again, or go to "Adjust Head1/ Standard" or "Adjust Head2/ Custom" to perform calibration.
- If a roll media starts to cockle during calibration, load the media again.

## Head alignment steps

---

[1] Turn the printer ON and load a roll media.

 ["Loading a roll media" P. 25](#)



Tap  (Home).



Tap  until the menu on the left appears.



• Tap  (Enter).

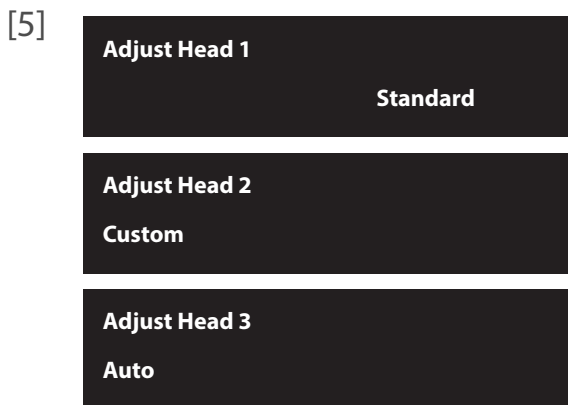

• Tap  until the menu on the left appears.

• Tap .



• Use  or  to choose the alignment method.

• Tap  (Enter).

[6] The printer will print the confirmation pattern.

[7] Follow the steps below to align the two print heads.

 ["Standard or Custom Adjustment Methods" P. 113](#)

 ["Auto Adjustment Method" P. 115](#)

## Print quality calibration

This menu calibrates the dot placement of bidirectional printing. Print the alignment pattern to see if dot placement is perfectly aligned. If misaligned, enter the alignment value to correct the accuracy of dot placement.

You can choose one of the following methods:

### \*\* : Adjust Print 1

Auto

Perform the automatic adjustment using the embedded color sensor. Allows you to adjust also a print mode other than the print mode used by the current user definition.

This method optimizes print quality even if the print mode on the RIP side is different from the user-defined mode.

### \*\* : Adjust Print 2

Standard

The Standard option performs dot placement alignment for the print mode saved in the currently selected user type.

When you use this option, make sure that the resolution, number of pass, and printing direction of the print mode on your RIP is the same as the print mode saved in the user type currently selected.

### \*\* : Adjust Print 3

Custom

Allows you to adjust also a print mode other than the print mode used by the current user definition.

This method optimizes print quality even if the print mode on the RIP side is different from the user-defined mode.



#### Note

- If you are suffering from print quality defects after changing installation site or a roll media loaded on the printer, perform the print quality calibration.
- If you change the user type after performing the Standard calibration, you need to perform the print quality calibration for the print mode chosen.
- Since all print modes are adjusted at once after performing Custom adjust print, adjust print is not required even after changing the print mode. When specifying a print mode for RIP software, etc, that is different from the mode set in the user type setting, perform Custom head adjustment and check all patterns (A to F), and then adjust any patterns that are misaligned beforehand.
- If you experience following problems, the head alignment can help to improve print quality:  
For adjustment procedure, see  ["Head alignment" P. 39](#)
  - Print quality is poor when using the uni-direction print mode.
  - Print quality does not improve by print quality calibration.
- After you have performed head adjustment, make sure you perform print quality adjustment. There may be misalignment caused by head adjustment.

## Print quality calibration steps

---

[1] Turn the printer ON and load a roll media.

 ["Loading a roll media" P. 25](#)



Tap  (Home).





Tap .





Tap .

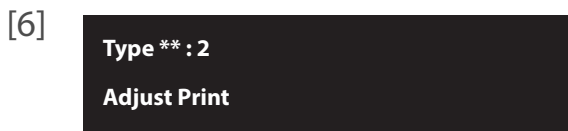

Use  or  to choose the user type you want to use.

• Tap  (Enter).





Tap  until the menu on the left appears.

• Tap .





Enter the thickness of the media.

• Use  or  to specify the thickness.

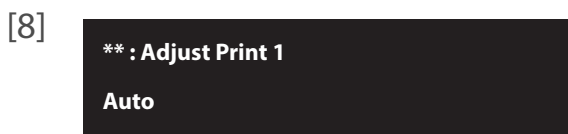
• Tap  (Enter).



Use  or  to choose the calibration method.

• Tap .

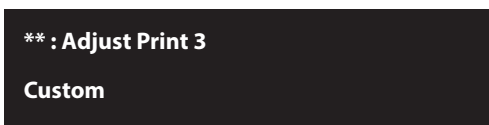
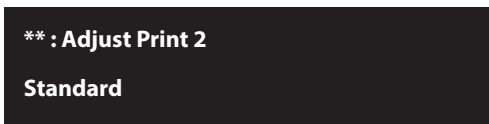



## Note

- In Standard print quality adjustment and Custom print quality adjustment, the names in the available patterns are different. For details, refer to the page below.

 ["Adjust Print 1: Auto" P. 76](#)

 ["Adjust Print 2: Standard" P. 76](#)

 ["Adjust Print 3: Custom" P. 77](#)

- For a pre-adjustment check, select "Confirm Pattern".  
Check the printing results in "Confirm Pattern".
  - To adjust large misalignment, select "Rough Pattern".
  - To adjust small misalignment, select "Fine Pattern".

[9] Follow the steps below and adjust the print quality.

 ["Auto Adjustment Method" P. 78](#)

 ["Standard or Custom Adjustment Methods" P. 79](#)

## Media feed adjustment

This adjustment must be performed when:

- you use this product for the first time.
- you use a new type of the media.
- you have changed the holddown pressure on the pressure rollers.

Other than above cases, move to ["Nozzle check and cleaning" P. 35](#).

### Note

If the following symptom appears on your print, this adjustment may help to solve the problem.

- Image overlapping.
- Horizontal white lines on the print.

## Media feed adjustment steps

[1] Load a roll media.

 ["Loading a roll media" P. 25](#)

[2]

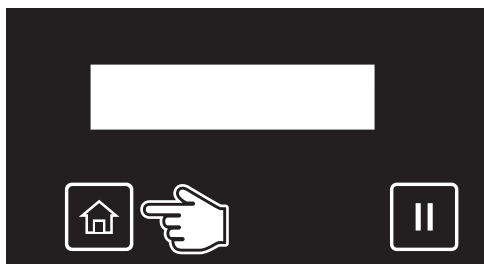

Tap  (Home).

[3]



Tap .



[4]



Tap .

[5]



Use  or  to choose the user type you want to use.

• Tap  (Enter).

[6]



Tap  until the menu on the left appears.

• Tap .

[7]



Tap .

[8] Follow the steps below and adjust the print quality.

 ["Automatic PF adjustment method:" P. 81](#)

# Advanced settings

Change your printer settings according to the type or condition of a roll media being loaded.

- If you get a head strike and ink smears on the media
  - 👉 ["Printhead Height" P. 46](#)
- To print on thin or soft media
  - 👉 ["Swapping left and right edge holders depending on the media type" P. 51](#)
  - 👉 ["Changing holddown pressure using media feed lever" P. 52](#)
  - 👉 ["Canceling or reducing pressure rollers individually" P. 53](#)

## Note



- When printing on thin media or media without stiffness, wrinkles can be prevented by turning down the vacuum fan.
  - 👉 ["7: Vacuum Fan" P. 87](#)

## Printhead Height

Normally choose the "Low1" or "Low2" head height option depending on the thickness of your media. The closer the gap between the media and the printhead, the better the consistency of the print quality.

### Important!

Depending on the condition of a roll media or media cockling caused by the printer settings, you may get a head strike causing ink smears on the media. In such cases, try followings:

- **Lower the temperature set for the preheater and the platen heater.**  
 ["Setup 1: User Type" P. 72](#) > ["4: Preheater" P. 86](#), ["5: Platen Heater" P. 86](#)
- **Reduce or cancel the pressure on the individual pressure rollers holding down the area where the cockling occurs.**  
 ["Canceling or reducing pressure rollers individually" P. 53](#)

See the table below for the relationship between the head height and the recommended media thickness.

Avoid using higher head height unless absolutely necessary, as the wider head gap will cause ink mist to adhere to the printhead nozzles, media or inside of the printer, adversely affecting print quality or leading to damage to the printer parts.

| Head height | Recommended media thickness (1.0 mm or less) | Maximum media thickness that printer can feed | Description  |
|-------------|--|---|--|
| Low1        | 0.3 mm or below                              | 0.3 mm  | Normally use this head height.   |
| Low2        | 0.3 mm to 0.8 mm                             | 0.8 mm  | Use this option for media between 0.3 mm to 0.8 mm thick or when the head strikes occurs with Low1 setting.  |
| Middle      | 0.8 mm to 1.0 mm                             | 1.3 mm  | Use this option for media between 0.8 mm to 1.0 mm thick or when the head strikes occurs with Low2 setting.  |
| High        | -  | 2.8 mm  | Avoid using this option if a head strike does not occur with Middle setting.<br>Because of wide distance between the print head and media, printing with "High" setting will generate ink mist, causing the following symptoms: <ul style="list-style-type: none"><li>• Jetting failure due to nozzle clogging</li><li>• Ink adhesion to media</li><li>• Ink adhesion to inside of the printer</li></ul> |

**Important!**

- **After you change the head height, make sure to perform the print quality calibration.**
- **Do not open Front cover and change the head height during printing.**  
**Print quality cannot be guaranteed.**
- **The type of cleaning wiper to be used varies by head height.**  
**When changing the head height, make sure to check the appropriate type of wiper for the selected head height and replace if needed.**
- **Depending on the head height of the printer, two types of cleaning wipers are available; black and grey.**  
**If the head height is set to Low1, Low2 or Middle, use a black wiper (normal type).**  
**If set to High, use a grey wiper (for head height High).**  
**You will not be able to perform cleaning properly if wrong type is used on the printer.**
- **This product is shipped with a black wiper attached.**

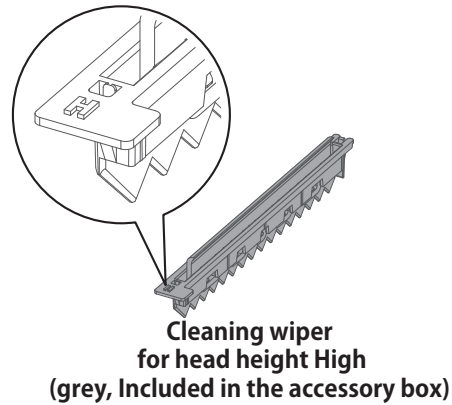
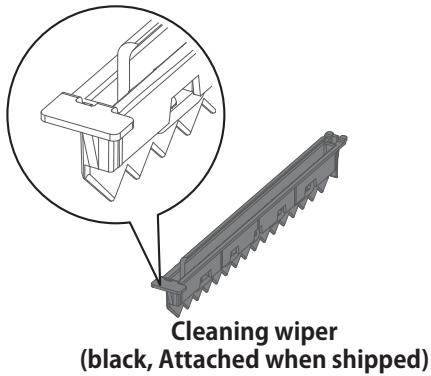

## 1. Changing the Head Height

[1]

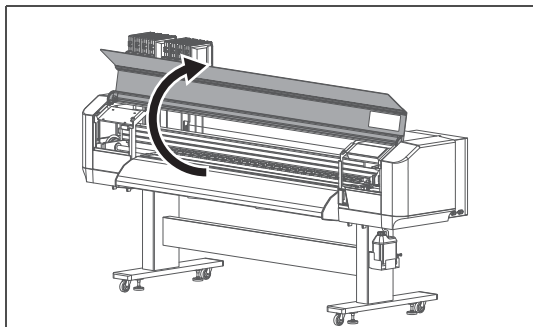

Open the front cover.

[2]

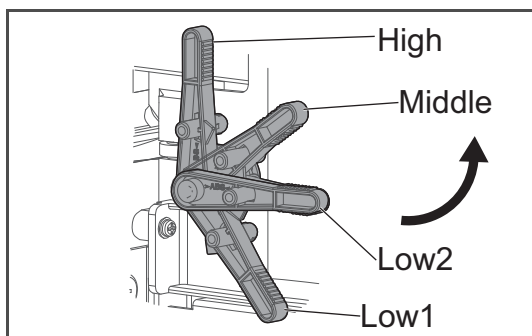

Use the head height adjustment lever (orange) to change the head height.

- High: The highest head height setting.
- Middle: Use this option for media between 0.8 mm to 1.0 mm thick or when the head strikes occurs with Low2 setting.
- Low2: Use this option for media between 0.3 mm to 0.8 mm thick or when the head strikes occurs with Low1 setting.
- Low1: Default head height. The lowest head height setting.

[3]

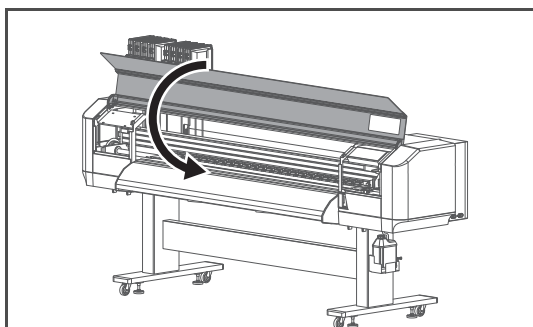

Close the front cover.

### Important!

**If you change the head height from "Low1", "Low2" or "Middle" to "High" and vice versa, change the cleaning wiper to an appropriate type.**

 ["Replacing with an appropriate cleaning wiper for the head height" P. 49](#)

[4]

Perform print quality calibration.

 ["Print quality calibration" P. 41](#)

## 2. Replacing with an appropriate cleaning wiper for the head height

[1] Put the printer into the CR maintenance mode.

 ["Putting the printer into the CR maintenance mode" P. 150](#)

[2] Open the front cover.

[3]  Open the maintenance cover on the right side.

[4] Cover the platen with the paper you can get dirty.

### Important!

**Ink may drip from the cleaning wiper.  
We recommend covering the floor with paper as well.**

[5]  Remove the cleaning wiper.

- Slide the hook on the wiper to the back to unhook from the wiper slot.
- Lift the hook and remove the cleaning wiper.

### Important!

- **Wear protective gloves while replacing.**
- **When removing the cleaning wiper, be cautious of ink drops.**

### Note

Used cleaning wiper should be put in a plastic bag, etc, and dispose of it in compliance with local ordinance and instructions of local authorities.

[6]  Attach an appropriate cleaning wiper to the wiper slot.

- Slide the front side of the new cleaning wiper into its slot.
- Press the wiper hook down until it clicks into place.

### Important!

**Do NOT touch the cleaning wiper rubber with your bare hand.  
If finger oil gets on the rubber, it will damage the print head.**

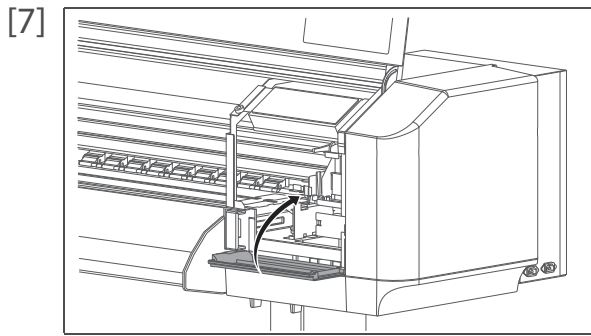

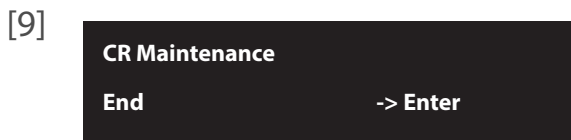

Close the maintenance cover.

[8] Close the front cover.

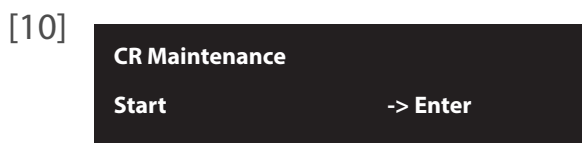

Tap  (Enter).



Tap  (Home) to end the cleaning process.

## Swapping left and right edge holders depending on the media type

The way to attach edge holders varies depending on type of roll media to be loaded.

To swap left and right edge holders, remove them from the platen, swap left and right, and attach them to the platen again.

- Normally attach them as shown in the figure below so that the hole on the edge holder is located on the outside of the holder. This will hold down roll media lightly.



- To print on thin or soft media, swap left and right edge holders and attach them as shown in the figure below so that the hole on the edge holder is located on the inside of the holder. This will hold down wider area on roll media.



### Steps

- [1] Open the front cover.
- [2] Slide both edge holders to the far left along the platen and remove them from the end of the platen.

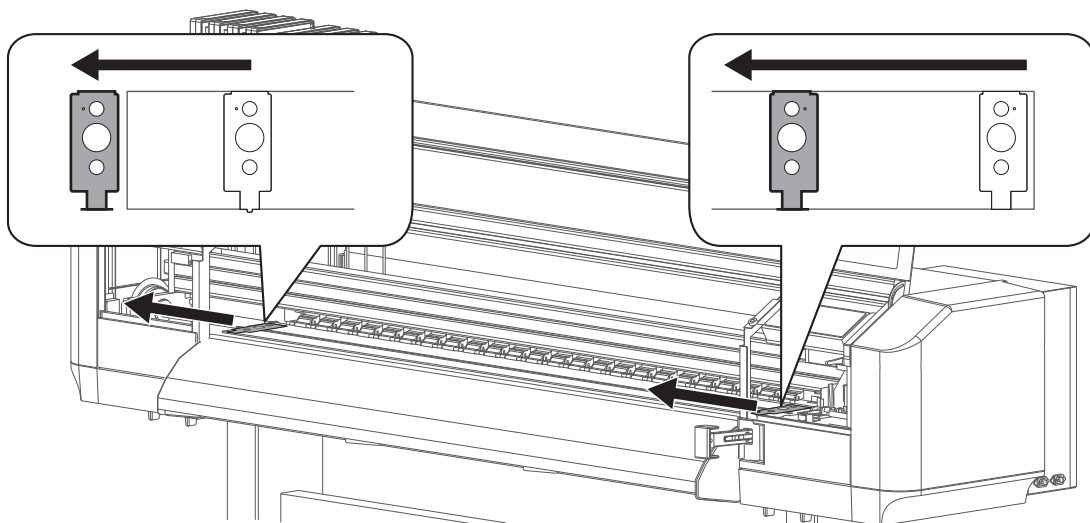

- [3] Swap left and right edge holders and attach them to the platen.
  - Insert the edge holders from the side of maintenance cover L and fit them to the groove on the platen to attach.

**Important!**

**If you swapped left and right edge holders, make sure to set the side margin correctly.**

["After loading the media..." P. 32](#)

["Setup 3: Side Margin" P. 89](#)

## Changing holddown pressure using media feed lever

If you want to change the holddown pressure applied across the entire width of media, use the media feed lever.

Depending on the position of the lever, you can choose the pressure between Normal and High.

- Normal: Recommended for typical roll media. To apply normal pressure, push the lever from the front side of the printer until it clicks.
- High: Recommended for heavy weight media (such as Tarpaulin). To apply high pressure, push it as far as it goes.

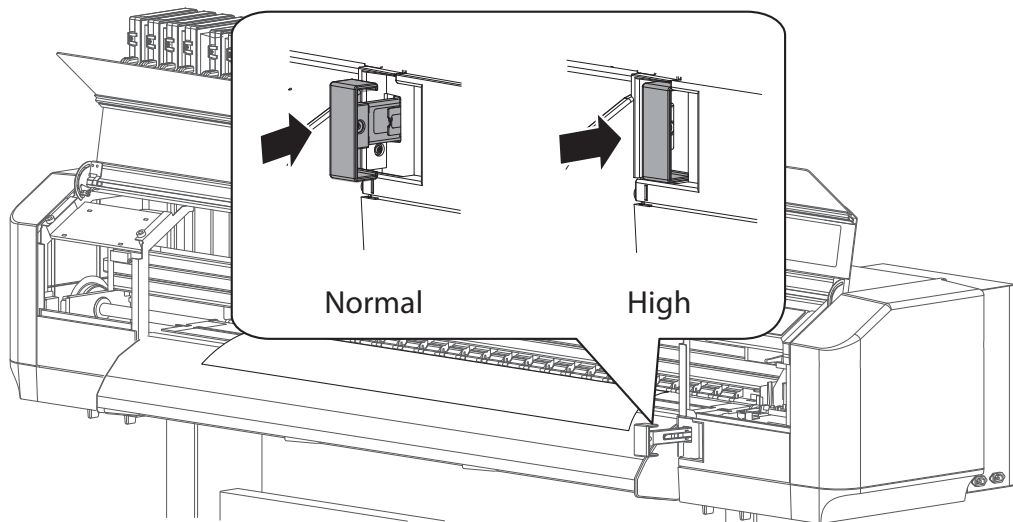

**Important!**

**Every time after you change the holddown pressure by the media feed lever, you must perform the media feed adjustment.**

["Media feed adjustment" P. 44](#)

## Canceling or reducing pressure rollers individually

When printing on thin media or media without stiffness, the media tends to cockle causing head strikes. By reducing pressure or disabling the pressure rollers individually, it helps to reduce the chance of head strike.

Using the slide lock lever on the individual pressure roller, the holddown pressure can be changed between Normal, Low and Cancel.

- Normal: Recommended for typical roll media. The factory default is set to Normal.
- Low: It reduces the holddown pressure.
- Cancel: It disables the pressure roller.

However, if the media feed lever is set to High, you can only choose between Normal and Cancel (even you set it to Low, the holddown pressure will not be reduced).

To cancel the individual pressure rollers, release the pressure rollers by pulling the media feed lever towards you as much as possible.

| Media feed lever | Slide lock lever    |
|------------------|---------------------|
| Normal           | Normal/ Low/ Cancel |
| High             | Normal/ Cancel      |

### Important!

**Every time after you change the holddown pressure by individual slide lock lever, you must perform the media feed adjustment.**

["Media feed adjustment" P. 44](#)

### Note

- Thin media or media without stiffness is likely to be wrinkled during printing. Wrinkles can contact the bottom side of the print head causing the media to become dirty. When both edges of the pressurizing rollers of media are released, it can prevent wrinkles.

## Procedure

[1] Open the front cover.

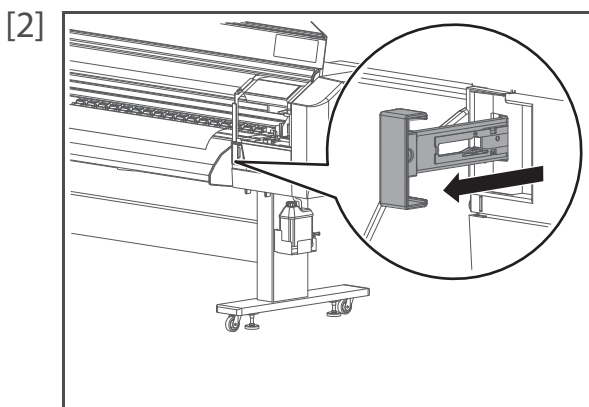

(To cancel the individual pressure rollers) From the front side of the printer, pull the media feed lever towards you as much as possible to release the pressure rollers.

(To set the slide lock lever to the Low position) Set the media feed lever to the Normal position.

["Changing holddown pressure using media feed lever" P. 52](#)

### Note

- You cannot cancel the individual pressure rollers unless you release the pressure rollers by the media feed lever.

- [3] Push down the tab on the slider lock lever, then slide it to the front.
- To reduce pressure, slide it to front until it clicks.
  - To cancel the pressure roller, fully slide it to the front until it clicks into place.

 **Note**

First, try to reduce or cancel the rollers on both edges of the media. If the problem persists, reduce or cancel more rollers.

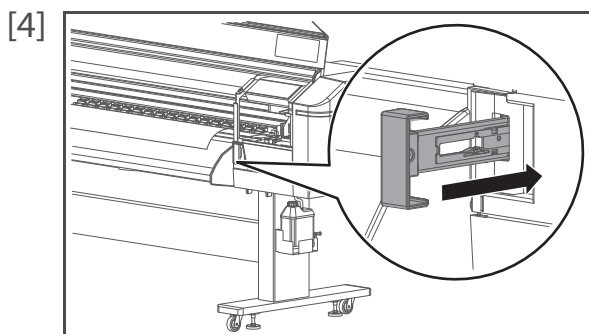
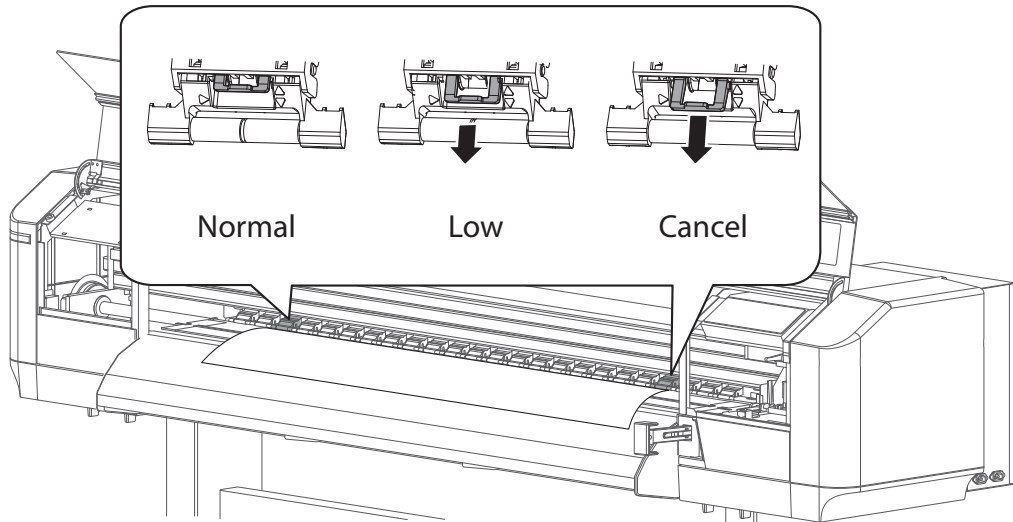



(To cancel the individual pressure rollers) Push the media feed lever back to the original position to lock the pressure rollers.



- [5] Close the front cover.
- [6] Perform media feed adjustment.  
 ["Media feed adjustment" P. 44](#)

# Operating from Front panel

## Feeding media

[1]  Check that the pressure rollers hold down the media.

[2]  Long-touch  or  to feed a roll media until it reaches to the desired position.

-  key: Feed the media backward.
-  key: Feed the media forward.

 Note

Long tap the key to feed the media with high speed.

[3] Once it has reached the intended position, release the key.

## Pausing / Restarting printing

[1]  Tap  (Cancel) while printing.

- The printer will pause the job.

 Note

- You cannot cancel the job by tapping  (Cancel).

- To cancel the job, see the following section.

 ["Canceling printing" P. 56](#)

[2]  Tap  (Cancel) again to resume printing.

 Important!

**MUTOH cannot guarantee the print quality when you resume the printing.**

## Canceling printing

[1]

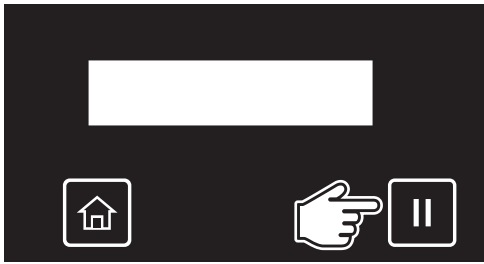

Tap  (Cancel) while printing.

- The printer will pause printing.



To resume printing, tap [Cancel] again.

[2]



Tap  (Enter) to cancel printing. (Once canceled, you cannot resume the job again.)

- The data sent to the printer will be deleted.



You can also cancel the job from the remote panel on MSM.

## Starting printing during warming up

[1]



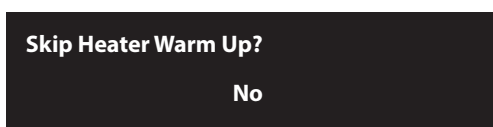

Check that the message "Warming Up" is displayed on the front panel.

[2]



Send a job to the printer.

- "Skip Heater Warm Up? No" is displayed on the front panel.
- Use  or  to choose "Yes".

- Tap  (Enter).

[3] Start printing.

### CAUTION



**While "Warming Up" is displayed, do not touch the media guide.**  
You could get burn injuries.







**If you start printing during warming up, print quality is not guaranteed.**



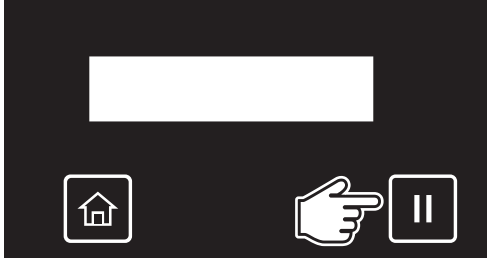

Even when you start printing during warming up, the printer continues to warm up the heater until it reaches to the specified temperature.

## Cutting media

- [1] 
- Check that the job has been printed.
- Tap  (Cancel).
- [2] 
- Tap  (Enter).
- The printer will advance the media for the bottom margin and will cut it.

### Note

- If the front edge of a new roll media is not straight, cut it before printing.
- When the media detection is set to "Off", the printer does not cut the media automatically.
  -  ["Setup 4: Media Initial" P. 90](#)
- When the Output mode menu is set to "Auto Cut", the printer cuts the media automatically after printing.
  -  ["Setup 6: Output Mode" P. 91](#)
- The cutter blade is consumable parts. Replace it when needed.
  -  ["Replacing Cutter" P. 162](#)

## Menus you can access while printing



[1]

|                   |                   |
|-------------------|-------------------|
| <b>Receiving</b>  |                   |
| <b>PG: Low1</b>   | <b>W: 1625 mm</b> |
| <b>Printing</b>   |                   |
| <b>PG: Low1</b>   | <b>W: 1625 mm</b> |
| <b>Converting</b> |                   |
| <b>PG: Low1</b>   | <b>W: 1625 mm</b> |

Tap  (Home) while one of the three messages on the left appears on the touch panel.

[2]

|                        |
|------------------------|
| <b>Menu 1</b>          |
| <b>Temperature</b>     |
| <b>Menu 2</b>          |
| <b>Preheater</b>       |
| <b>Menu 3</b>          |
| <b>Platen Heater</b>   |
| <b>Menu 4</b>          |
| <b>Dryer</b>           |
| <b>Menu 5</b>          |
| <b>PF Micro Adjust</b> |
| <b>Menu 6</b>          |
| <b>Backup</b>          |
| <b>Menu 7</b>          |
| <b>Job Status</b>      |
| <b>Menu 8</b>          |
| <b>MPS</b>             |

Use  or  to choose the menu, then tap .

 ["Menu 1: Temperature" P. 59](#)

 ["Menu 2: Preheater" P. 59](#)

 ["Menu 3: Platen Heater" P. 60](#)

 ["Menu 4: Dryer" P. 60](#)

 ["Menu 5: PF Micro Adjustment" P. 61](#)

 ["Menu 6: Backup" P. 61](#)

 ["Menu 7: Job Status" P. 62](#)

 ["Menu 8: MPS" P. 62](#)

## Menu 1: Temperature

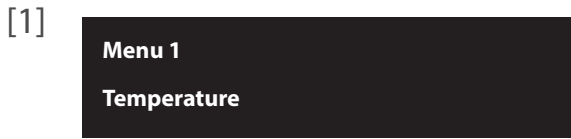

---

You can check the temperature of the heater during printing.

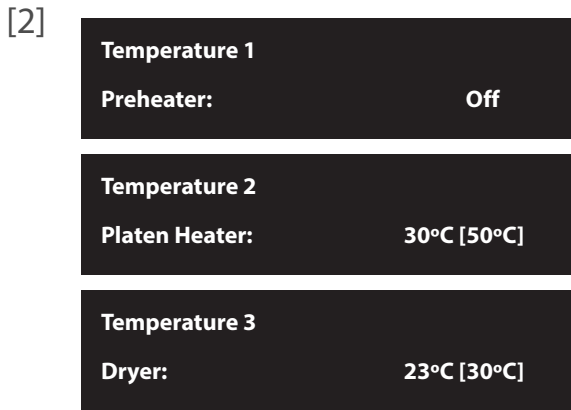

Tap .



Use  or  to choose the heater you want to check.

- It displays the current heater temperature and heater temperature setting in square brackets.

### Note

- Indicated temperature is approximate. The accuracy of the temperature is not guaranteed.
- The display of the current temperature blinks all the time even the heater still warms up or has reached the target temperature.

## Menu 2: Preheater

---

You can change the preheater temperature setting for the current print job.



- See the following related sections of Panel Setting Menus:

 ["\\*\\*\\*>4: Preheater" P. 86](#)



Tap .



Use  or  to change the value.

- Tap  (Enter) to confirm the change.

### Note

- The change made is applied to the current job only and is not saved in the printer.
- To save the change in the user type currently selected, go to "Menu 6: Backup".

### CAUTION



The message "Warming up" appears while the heater is functioning.  
**While "Warming Up" is displayed, do not touch the media guide.**  
You could get burn injuries.

## Menu 3: Platen Heater

---

You can change the platen heater temperature setting for the current print job.

- See the following related sections of Panel Setting Menus:

 [\\*\\*\\*>5: Platen Heater" P. 86](#)



[1]



Tap .

[2]



Use  or  to change the value.

- Tap  (Enter) to confirm the change.



- The change made is applied to the current job only and is not saved in the printer.
- To save the change in the user type currently selected, go to "Menu 6: Backup".

### CAUTION



The message "Warming up" appears while the heater is functioning.

**While "Warming Up" is displayed, do not touch the media guide.**

You could get burn injuries.

## Menu 4: Dryer

---

You can change the dryer temperature setting for the current print job.

- See the following related sections of Panel Setting Menus:

 [\\*\\*\\*>6: Dryer" P. 86](#)



[1]



Tap .

[2]



Use  or  to change the value.

- Tap  (Enter) to confirm the change.



- The change made is applied to the current job only and is not saved in the printer.
- To save the change in the user type currently selected, go to "Menu 6: Backup".

### CAUTION



The message "Warming up" appears while the heater is functioning.

**While "Warming Up" is displayed, do not touch the media guide.**

You could get burn injuries.

## Menu 5: PF Micro Adjustment

---

You can change the micro adjustment value to correct media feeding for the currently print job.



- See the following related sections of Panel Setting Menus:

 ["\\*\\*\\*>3: PF Adjust" P. 81](#)

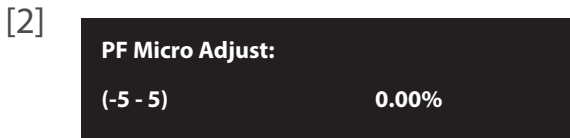

Tap .



Use  or  to change the value.

- Tap  (Enter) to confirm the change.



- The change made is applied to the current job only and is not saved in the printer.
- To save the change in the user type currently selected, go to "Menu 6: Backup".

## Menu 6: Backup

---

You can save the change that you made on "Menu2: Preheater", "Menu3: Platen Heater", "Menu4: Dryer" and "Menu5: PF Micro Adj." in the currently selected user type.



Tap .

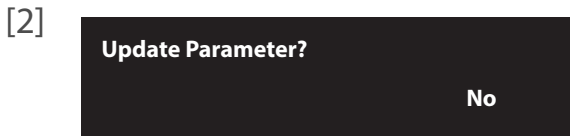

Use  or  to select "Yes".

- Tap  (Enter).

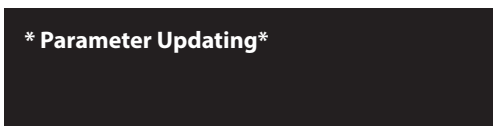

The change is saved in the selected user type.

## Menu 7: Job Status

---

You can check the current status of the print job being printed.

- See the following related sections of Panel Setting Menus:

 ["Menu 8: Job Status" P. 125](#)



[1]

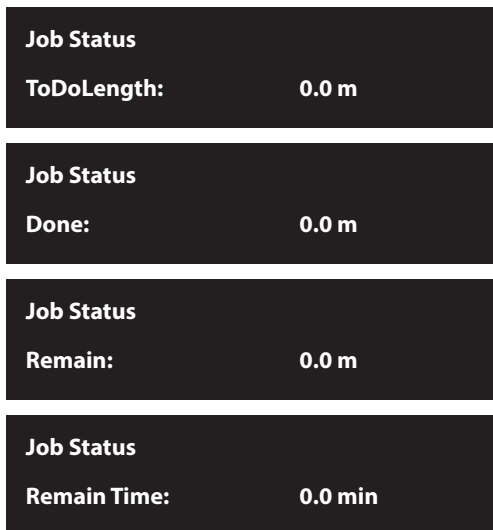

Tap .

[2]



Use  or  to choose the information you want to check.

- ToDoLength: displays the length of the current job (in media feeding direction).
- Done: displays the length of the current job that has been already printed.
- Remain: displays the remaining length to finish printing.
- Remain time: displays remaining time to finish printing.



### Note

- Indicated value is approximate. The accuracy of the value is not guaranteed.
- If the print job data does not contain length information, "0" will be displayed in the Job Status menu.

## Menu 8: MPS

---

You can check the status of MPS.

[1]



Tap .

[2]



The status of MPS is displayed On or Off.



### Note

- The MPS settings can be changed in MSM.

# Chapter 2 Advanced Operations

|   |            |
|---|------------|
| <b>Introduction</b> .....   | <b>65</b>  |
| Operating the keys to use the menus .....                                   | 65         |
| Panel setup menu .....  | 67         |
| <br>  |            |
| <b>Menu 1: Setup</b> .....  | <b>72</b>  |
| Setup 1: User Type .....  | 72         |
| Setup 2: Spitting .....   | 88         |
| Setup 3: Side Margin .....  | 89         |
| Setup 4: Media Initial .....  | 90         |
| Setup 5: Media Width .....  | 90         |
| Setup 6: Output Mode .....  | 91         |
| Setup 7: Method of Cut .....  | 92         |
| Setup 8: Origin .....   | 93         |
| Setup 9: Prevent Stick menu .....   | 94         |
| Setup 10: Standby Heating .....   | 94         |
| Setup 11: Head Travel .....   | 94         |
| Setup 12: Multi Strike .....  | 95         |
| Setup 13: Strike Wait .....   | 95         |
| Setup 14: Slant Check .....   | 95         |
| Setup 15: Auto Cleaning .....   | 96         |
| Setup 16: Exhaust Fan .....   | 97         |
| Setup 17: Longstore .....   | 98         |
| Setup 18: Initialization .....  | 98         |
| Setup 19: Header Dump .....   | 99         |
| Setup 20: Head Select .....   | 100        |
| Setup 21: Select Nozzle .....   | 101        |
| Setup 22: Heater Control .....  | 103        |
| Setup 23: Start Feed .....  | 103        |
| Setup 24: Internal LED Lights .....   | 104        |
| Setup 25: Front Interlace .....   | 104        |
| Setup 26: Auto Nozzle Check (Requiring the optional drop sensor unit) ..... | 105        |
| Setup 27: Power Off .....   | 107        |
| Setup 28: Temporary .....   | 108        |
| <br>  |            |
| <b>Menu 2: Test Print</b> .....   | <b>109</b> |
| Test Print 1: Nozzle Check .....  | 109        |
| Test Print 2: Nozzle Check F .....  | 110        |
| Test Print 3: Mode Print .....  | 110        |
| Test Print 4: Setup List .....  | 111        |
| Test Print 5: Palette .....   | 111        |
| Test Print 6: Adjust Head .....   | 112        |
| <br>  |            |
| <b>Menu 3: Cleaning</b> .....   | <b>116</b> |
| Menu3: Cleaning .....   | 116        |

|  |                |
|--|----------------|
| <b>Menu 4: Menu Option</b> .....           | <b>117</b>     |
| Menu4: Menu Option .....                   | 117            |
| <br><b>Menu 5: System Info.</b> .....      | <br><b>118</b> |
| Ink Status .....                           | 118            |
| Life Times .....                           | 119            |
| <br><b>Menu 6: Sleep Mode</b> .....        | <br><b>120</b> |
| Sleep Mode 1: Cleaning Setting .....       | 120            |
| Sleep Mode 2: Auto Sleep Timer .....       | 120            |
| Sleep Mode 3: Start .....                  | 121            |
| <br><b>Menu 7: Initial Settings</b> .....  | <br><b>122</b> |
| Initial Settings 1: Language .....         | 122            |
| Initial Settings 2: Temperature .....      | 122            |
| Initial Settings 3: Length .....           | 123            |
| Initial Settings 4: IP Address .....       | 123            |
| Initial Settings 5: Subnet Mask .....      | 123            |
| Initial Settings 6: Gateway .....          | 124            |
| Initial Settings 7: Alert Buzzer .....     | 124            |
| <br><b>Menu 8: Job Status</b> .....        | <br><b>125</b> |
| <br><b>Menu9: Roll Length Manage</b> ..... | <br><b>126</b> |
| Roll Length Manage1: Print .....           | 127            |
| Roll Length Manage2: Simple Print .....    | 127            |
| Roll Length Manage3: Scan .....            | 128            |
| Roll Length Manage4: Roll Length .....     | 129            |
| Roll Length Manage5: Auto Scan .....       | 130            |
| Roll Length Manage6: Auto Print .....      | 131            |
| <br><b>Menu10: Media Adjustment</b> .....  | <br><b>132</b> |
| <br><b>Menu11: CR Maintenance</b> .....    | <br><b>134</b> |
| <br><b>Menu chart</b> .....                | <br><b>135</b> |
| Setting menu 1 .....                       | 135            |
| Setting menu 2 .....                       | 136            |
| Setting menu 3 .....                       | 137            |
| Menu during printing .....                 | 138            |

# Introduction

Using the panel setting menus, configure various kinds of settings for the printer.

## Operating the keys to use the menus



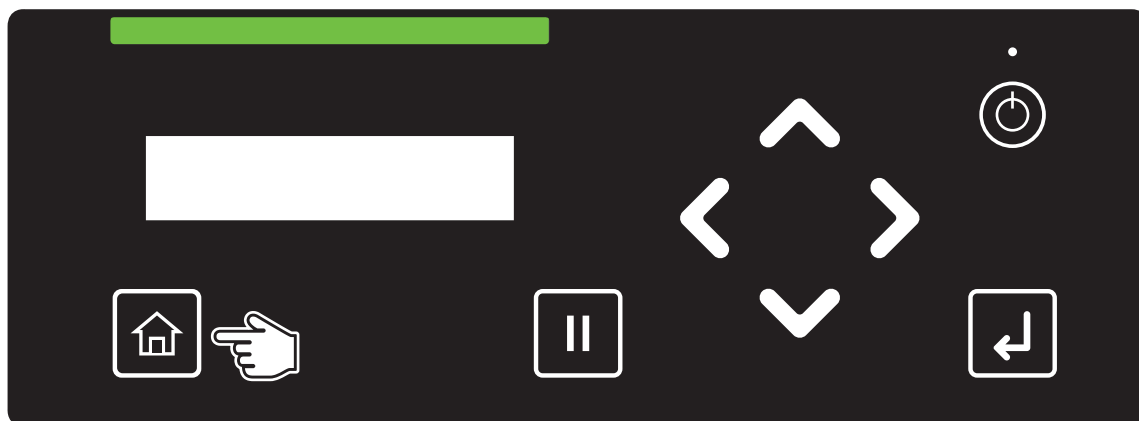



[1] To access to the setup menu, tap  (Home).



### Note



You cannot access to the setup menu while printing or receiving data (the power button is flashing).

[2]

|   |   |
|---|---|
|  | Use  or  to go to the previous item or next item. |
|  | Use  to go to the sub menu.  |
|  |   |
| ⋮   |   |
|  |   |

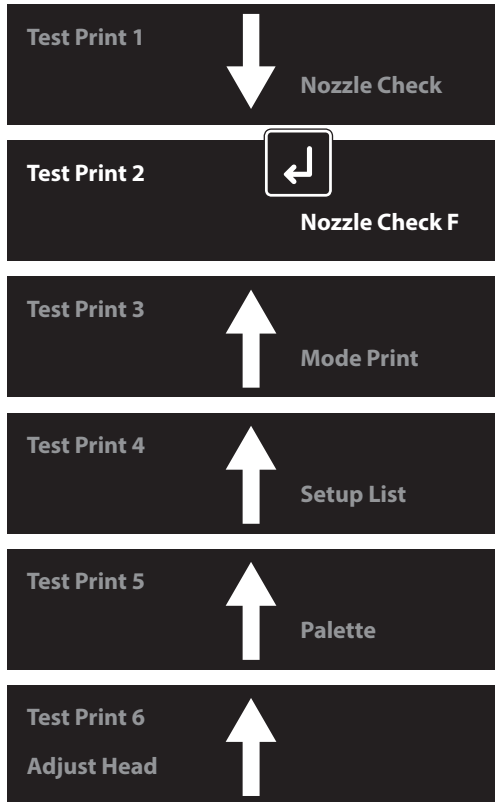
[3]



Use  or  to choose the option from the sub menu or enter the value.

To confirm the value or execute the selected function, tap  (Enter).

Use  to return to the upper level menu.















(In the example on the left, the display will return to “Menu2: Test Print“.)

Menu 1: Setup















Menu 1  
Setup

Configure printer settings.

Submenus

- Setup1  
User Type  [Setup 1: User Type](#)
- Setup 2  
Spitting  [Setup 2: Spitting](#)
- Setup 3  
Side Margin  [Setup 3: Side Margin](#)
- Setup 4  
Media Initial  [Setup 4: Media Initial](#)
- Setup 5  
Media Width  [Setup 5: Media Width](#)
- Setup 6  
Output Mode  [Setup 6: Output Mode](#)
- Setup 7  
Method of Cut  [Setup 7: Method of Cut](#)
- Setup 8  
Origin  [Setup 8: Origin](#)
- Setup 9  
Prevent Stick  [Setup 9: Prevent Stick menu](#)
- Setup 10  
Standby Heating  [Setup 10: Standby Heating](#)
- Setup 11  
Head Travel  [Setup 11: Head Travel](#)
- Setup 12  
Multi Strike  [Setup 12: Multi Strike](#)
- Setup 13  
Strike Wait  [Setup 13: Strike Wait](#)
- Setup 14  
Slant Check  [Setup 14: Slant Check](#)

|                               |
|-------------------------------|
| Setup 15<br>Auto Cleaning     |
| Setup 16<br>Exhaust Fan       |
| Setup 17<br>Longstore         |
| Setup 18<br>Initialization    |
| Setup 19<br>Header Dump       |
| Setup 20<br>Head Select       |
| Setup 21<br>Select Nozzle     |
| Setup 22<br>Heater Control    |
| Setup 23<br>Start Feed        |
| Setup 24<br>LED Light         |
| Setup 25<br>Front Interlace   |
| Setup 26<br>Auto Nozzle Check |
| Setup 27<br>Power Off         |
| Setup 28<br>Temporary         |

-  [Setup 15: Auto Cleaning](#)
-  [Setup 16: Exhaust Fan](#)
-  [Setup 17: Longstore](#)
-  [Setup 18: Initialization](#)
-  [Setup 19: Header Dump](#)
-  [Setup 20: Head Select](#)
-  [Setup 21: Select Nozzle](#)
-  [Setup 22: Heater Control](#)
-  [Setup 23: Start Feed](#)
-  [Setup 24: Internal LED Lights](#)
-  [Setup 25: Front Interlace](#)
-  [Setup 26: Auto Nozzle Check  
\(Requiring the optional drop sensor unit\)](#)
-  [Setup 27: Power Off](#)
-  [Setup 28: Temporary](#)

## Menu 2: Test Print

---

Menu 2  
Test Print

Run a test print to check for nozzle condition, current printer settings, printer configuration, color palette, and print head alignment.

### Submenus

---

Test Print 1

Nozzle Check

 [Test Print 1: Nozzle Check](#)

Test Print 2

Nozzle Check F

 [Test Print 2: Nozzle Check F](#)

Test Print 3

Mode Print

 [Test Print 3: Mode Print](#)

Test Print 4

Setup List

 [Test Print 4: Setup List](#)

Test Print 5

Palette

 [Test Print 5: Palette](#)

Test Print 6

Adjust Head

 [Test Print 6: Adjust Head](#)

## Menu 3: Cleaning

---

Menu 3  
Cleaning

Perform the print head cleaning and initial ink charging.

 [Menu 3: Cleaning](#)

## Menu 4: Menu Option

---

Menu 4  
Menu Option

Choose to show or hide the menus that are displayed in “Menu 1: Setup”.

 [Menu 4: Menu Option](#)

## Menu 5: System Information

---

Menu 5  
System Info.

Display the system information on your printer.

 [Menu 5: System Info.](#)

## Menu 6: Sleep Mode



---

Menu 6  
Sleep Mode

Choose the head cleaning mode and timer to be performed before entering to or while in sleep mode.

---

### Submenus

-  [Sleep Mode 1: Cleaning Setting](#)
-  [Sleep Mode 3: Start](#)

## Menu 7: Initial Settings







---

Menu 7  
Initial Settings

Configure the initial settings including display language and unit of measurement.

---

### Submenus

-  [Initial Settings 1: Language](#)
-  [Initial Settings 2: Temperature](#)
-  [Initial Settings 3: Length](#)
-  [Initial Settings 4: IP Address](#)
-  [Initial Settings 5: Subnet Mask](#)
-  [Initial Settings 6: Gateway](#)
-  [Initial Settings 7: Alert Buzzer](#)

## Menu 8: Job Status

---

Menu 8  
Job Status

Displays the last print job status.

-  [Menu 8: Job Status](#)

## Menu 9: Roll Length Manage

---

Menu 9  
Roll Length Manage

Specify the remaining roll length settings.

-  [Menu9: Roll Length Manage](#)

## Menu 10: Media Adjustment

---

Menu 10  
Media Adjustment

Automatically performs print quality calibration and media feed adjustment.

 [Menu10: Media Adjustment](#)

## Menu 11: CR Maintenance

---

Menu 11  
CR Maintenance

Moves the carriage and peripheral components to the maintenance position.

 [Menu11: CR Maintenance](#)

# Menu 1: Setup

## Setup 1: User Type

Setup1  
User Type

You can have up to 15 groups of User Type, labeled "Type1" to "Type15". When you select a User Type group ("Type") and tap  (Enter), that definition group will be set for the printer. Also, a submenu will be displayed.

### Setting values

User Type:

Type 1

Select a "Type" number, from "Type1" to "Type15".



**Important!**

**When you change to another User Type, all the settings that can be set via the User Type will be changed.**

**The following settings can be saved in the user type.**

- Settings for "Print Mode", "Effect"
- Adjustment values for "Adjust Print", "PF Adjust"
- Settings for "Preheater", "Platen Heater", "Dryer", "Vacuum Fan" and "Thickness"

**When using the printer for the first time or using a new roll media, configure a user type settings.**

User Type:

Type 1

Making media settings.

---

Submenus

---

Type \*\*: 1  
Print Mode

 **\*\*>1: Print Mode**

Type \*\*: 2  
Adjust Print

 **\*\*>2: Adjust Print**

Type \*\*: 3  
PF Adjust

 **\*\*>3: PF Adjust**

Type \*\*: 4  
Preheater

 **\*\*>4: Preheater**

Type \*\*: 5  
Platen Heater

 **\*\*>5: Platen Heater**

Type \*\*: 6  
Dryer

 **\*\*>6: Dryer**

Type \*\*: 7  
Vacuum Fan

 **\*\*>7: Vacuum Fan**

Type \*\*: 8  
Thickness

 **\*\*>8: Thickness**

Type \*\*: 9  
Copy User Type

 **\*\*>9: Copy User Type**

## \*\*>1: Print Mode

---

Type \*\*: 1  
Print Mode

Select a print mode for the media.

- Once selected, the panel displays the effect menu.

---

Setting values

---

\*\* : Mode :  
High Quality

Select this if you are looking for better print quality than the Fine print mode.

\*\* : Mode :  
Quality

Select this for high quality printing.

\*\* : Mode :  
Production

Select this for high-speed printing.

\*\* : Mode :  
High Speed

Select this if you want to maximize productivity.

## Details of print mode

| Print mode   | Default effect settings |
|--------------|-------------------------|
| High Quality | i-ScreenFine            |
| Quality      | i-ScreenFineX           |
| Production   | i-ScreenFine            |
| High Speed   | i-ScreenFine            |

## Effect

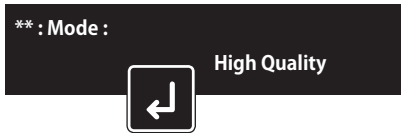

Select an effect setting.

Set up this menu when you want to improve print quality by adjusting the set print mode.

### Setting values



The Effect function is not used.



Effect with higher speed than i-Screen Fine.



Effect with better quality than i-Screen FineX.

## \*\*>2: Adjust Print

Type \*\*:2  
Adjust Print

Sets up when adjusting the printer for the optimum quality of image print.  
Before adjusting this setting, enter the thickness of the media.

### Submenus

\*\* : Adjust Print 1  
Auto

Perform an automatic calibration that the printer automatically prints and scans a pattern with the embedded color sensor to correct dot placement.

\*\* : Adjust Print 2  
Standard

Adjusts only the print mode in the user type setting which is currently set.

\*\* : Adjust Print 3  
Custom

Adjusts the print modes other than the mode in the user type setting which is currently set.



### Note

"Adjust Print" requires at least 550 mm printable width. Before printing, make sure that there is sufficient width on the media. If printable width is less than 550 mm, your printer will not perform printing. Printable width on the media can be adjusted by changing CR origin and side margin (left and right side margin) settings.

 ["Setup 5: Media Width" P. 90](#), ["Setup 8: Origin" P. 93](#), ["Setup 3: Side Margin" P. 89](#)

## Adjust Print 1: Auto

\*\* : Adjust Print 1  
Auto

Perform the automatic adjustment using the embedded color sensor.

 ["Auto Adjustment Method" P. 78](#)

---

### Submenus

\*\* : Auto 1

ALL

Perform automatic adjustment for all patterns (A to F) using the color sensor.

\*\* : Auto 2

Standard

Perform automatic adjustment for the currently selected print mode using the color sensor (calibrate the same print mode as "[Adjust Print 2: Standard](#)").

\*\* : Auto 3

Adjust Pattern A

Choose the adjustment pattern between A and F for automatic adjustment.

·  
·  
·

\*\* : Auto 6

Adjust Pattern F

## Adjust Print 2: Standard

\*\* : Adjust Print 2  
Standard

Adjusts only the print mode in the user type setting which is currently set.

 ["Confirm pattern" P. 79](#)

 ["Rough adjustment pattern" P. 80](#)

 ["Fine adjustment pattern" P. 80](#)

---

### Submenus

\*\* : Standard 1

Confirm Pattern

Print the test pattern for the adjustment. Check before adjusting.

\*\* : Standard 2

Rough Pattern

Perform this to adjust large misalignment. Print Adjust pattern and enter the set value.

\*\* : Standard 3

Fine Pattern

Perform this to adjust small misalignment. Print Adjust pattern and enter the set value.

## Adjust Print 3: Custom

\*\* : Adjust Print 3  
Custom

Perform adjustment for all patterns (A to F).

 ["Confirm pattern" P. 79](#)

 ["Rough adjustment pattern" P. 80](#)

 ["Fine adjustment pattern" P. 80](#)

---

### Submenus

\*\* : Custom 1

Confirm Pattern

The test patterns of A to F will be printed for Adjust print. Check before adjusting.

\*\* : Custom 2

Rough Pattern ALL

For printing all rough adjustment patterns from A to F.

\*\* : Custom 3

Rough Pattern A

For printing an adjust pattern selected from A to F.

•  
•  
•

\*\* : Custom 8

Rough Pattern F

\*\* : Custom 9

Fine Pattern ALL

For printing all fine adjustment patterns from A to F.

\*\* : Custom 10

Fine Pattern A

For printing an adjust pattern selected from A to F.

•  
•  
•

\*\* : Custom 15

Fine Pattern F

## Adjustment patterns for each print mode



| Print mode   | Adjustment pattern |
|--------------|--------------------|
| High Quality | F                  |
| Quality      | F                  |
| Production   | F                  |
| High Speed   | E                  |

### Note

If "Head Speed" is set to "Low" in your RIP software, select the adjustment pattern A, B or C.

The name of Head Speed menu varies depending on the RIP software you are using.

## Auto Adjustment Method

1. Select the adjustment pattern from "ALL", "Standard", or any specific pattern between "Adjust Pattern A" and "Adjust Pattern F".
  - The selected adjustment pattern is printed.
  - The printer scans the print using the embedded color sensor, then automatically corrects the dot placement.
2. Once successfully completed, the message "Auto Adjust Succeeded End->Enter" will appear on the panel.
  - If failed, the message "Auto Adjust Failed End -> Enter" will appear on the panel.Tap  (Enter) to end the adjustment.
  - Try Auto Adjust again or perform Standard or Custom adjustment.
3. Tap  (Enter) to exit the menu.

### Note

- If failed in the middle of the calibration, the adjustment value for the pattern which has been successfully calibrated will be saved in the printer, but the adjustment value for the pattern which has been failed to calibrate or has not been calibrated yet will not be saved in the printer.
- Warm up the heater before printing the Confirm and Adjustment patterns.  
"Skip Heater Warm Up? No" is displayed on the front panel.
- You can start printing while the printer is warming up.  
 ["Starting printing during warming up" P. 56](#)
- If print defects (like banding or grainy look) still appear on the print, try an auto calibration again, or go to "Adjust Print2/ Standard" or "Adjust Print3/ Custom" to perform calibration.
- If a roll media starts to cockle during calibration, load the media again.

### CAUTION



**While "Warming Up" is displayed, do not touch Media guide.**  
You could burn yourself.

## Standard or Custom Adjustment Methods

1. Print a confirm pattern and check it for printing errors.
2. Print "Rough pattern" and look for a place that is properly adjusted in the printing results of print head 1.
  - If you selected " **Adjust Print 3: Custom**", select "ALL" or "A" to "F".
  - The number printed under the pattern without alignment errors is the adjustment value.
3. Enter the adjustment values.
4. Follow the same procedure to adjust print head 2.
5. Print "Fine pattern" and look for a place that is properly adjusted in the printing results of print head 1.
  - If you selected " **Adjust Print 3: Custom**", select "ALL" or "A" to "F".
  - The number printed under the pattern without alignment errors is the adjustment value.
6. Enter the adjustment values.
7. Follow the same procedure to adjust print head 2.

### Note

- Warm up the heater before printing the Confirm and Adjustment patterns.  
"Skip Heater Warm Up? No" is displayed on the front panel.
- You can start printing while the printer is warming up.  ["Starting printing during warming up" P. 56](#)

### CAUTION



**While "Warming Up" is displayed, do not touch Media guide.**

You could burn yourself.

## Confirm pattern



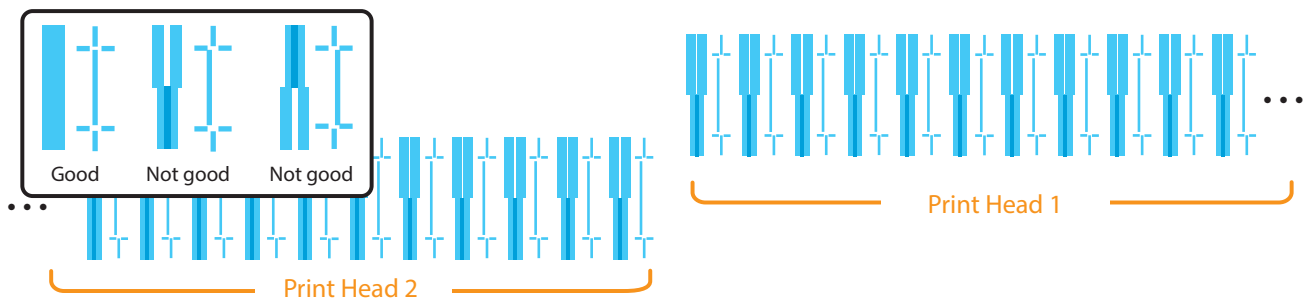

- Tap  (Enter) to carry out printing.
- Check the printing results. If there are shifting problems, proceed to rough adjustment pattern printing.
- In the picture below, there are misalignments.



### Note



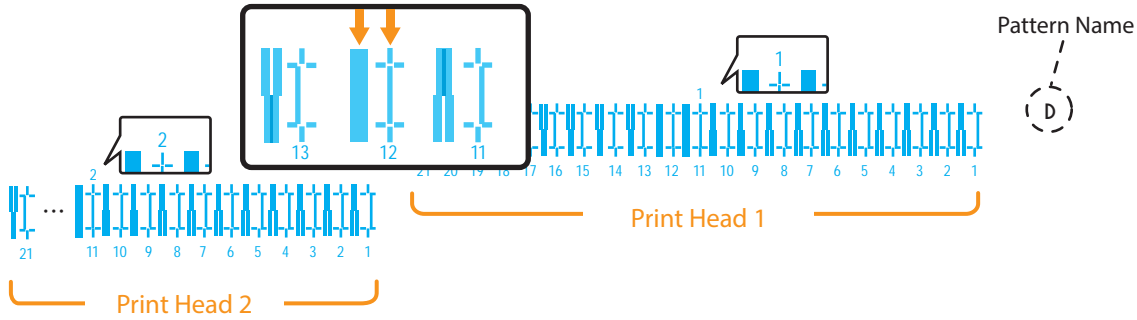

Because this printer has 2 Print heads, 2 rows of confirmation pattern will be printed.

## Rough adjustment pattern

- Tap  (Enter) to carry out printing.
- For Head 1, check the print results and select the number that looks most aligned between 1 and 21.
- Pattern names such as “Pattern D1: 11” are shown on the display. Use  or  to enter the number of the best-adjusted pattern, and tap  (Enter).
- In the case of the picture below, enter “12”, so that the display reads “Pattern D1: 12”. Follow the same procedure to adjust print head 2.



## Fine adjustment pattern

- Tap  (Enter) to carry out printing. For the Fine pattern, the same patterns will be printed repeatedly on both sides and center of the media.
- For Head 1, check the print results on both sides and center of the media and select the number that looks most aligned between 1 and 7.
- Pattern names such as “Pattern D1: 4” are shown on the display. Use  or  to enter the number of the best-adjusted pattern, and tap  (Enter).
- In the case of the picture below, enter “6”, so that the display reads “Pattern D1: 6”. Follow the same procedure to adjust print head 2.

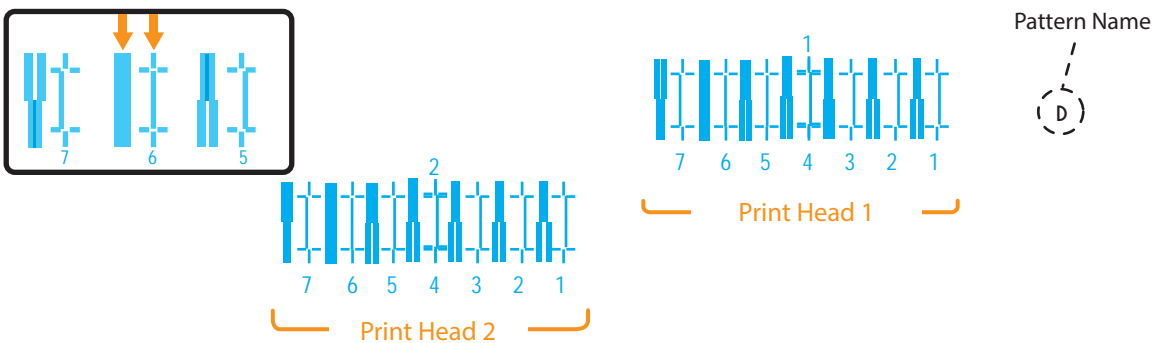

## \*\*>3: PF Adjust







Type \*\*: 3  
PF Adjust

Sets up various settings on the Media feed correction.

When the following defects are found in printing results, they may improve by conducting a media feed correction.

- Images are overlapping.
- There are white lines in images.

### Submenus

|                                    |   |
|------------------------------------|---|
| ** : PF Adjust 1<br>Auto           |  <a href="#">"PF Adjust 1: Auto" P. 83</a>           |
| ** : PF Adjust 2<br>Initial Print  |  <a href="#">"PF Adjust 2: Initial Print" P. 83</a>  |
| ** : PF Adjust 3<br>Initial Change |  <a href="#">"PF Adjust 3: Initial Change" P. 84</a> |
| ** : PF Adjust 4<br>Confirm Print  |  <a href="#">"PF Adjust 4: Confirm Print" P. 84</a>  |
| ** : PF Adjust 5<br>Micro Print    |  <a href="#">"PF Adjust 5: Micro Print" P. 85</a>    |
| ** : PF Adjust 6<br>Micro Change   |  <a href="#">"PF Adjust 6: Micro Change" P. 85</a> |

### Note

"PF Adjust" requires at least 400 mm printable width. Before printing, make sure that there is sufficient width on the media.

If printable width is less than 400 mm, your printer will not perform printing. Printable width on the media can be adjusted by changing CR origin and side margin (left and right side margin) settings.

 ["Setup 5: Media Width" P. 90](#), ["Setup 8: Origin" P. 93](#), ["Setup 3: Side Margin" P. 89](#)

### Automatic PF adjustment method:





#### 1. Select " [PF Adjust 1: Auto](#)".

- The printer automatically performs a PF adjustment.
- If the print defect persists after automatic PF adjustment, perform manual PF adjustment.

 ["Manual PF adjustment method using adjustment print." P. 82](#)

## Manual PF adjustment method using adjustment print.

You will need a ruler to perform this adjustment.

1. Select " **PF Adjust 2: Initial Print**".
  - "Feed Length: 250 mm" is displayed on the front panel.
2. After the initial adjustment printing, cut the media.
  - Measure the distance between the " + " in the initial adjustment print using a ruler.
3. Refer to Chapter 1 "**Media feed adjustment steps**" P. 44 and select " **PF Adjust 3: Initial Change**" on the front panel.
4. Use  or  on the front panel and enter the measured value in Step 2.
  - Tap  (Enter) to save the initial adjustment value.
5. Use  or  on the front panel to select " **PF Adjust 4: Confirm Print**".
  - "Feed Length: 250 mm" is displayed on the front panel.
6. After the confirmation adjustment printing, cut the media.
  - Measure the distance between the " + " in the confirmation adjustment print using a ruler. Then, confirm that the distance matches the feeding length when printing.
  - If the distance does not match the feeding length, follow the procedure from Step 1 to Step 5 and readjust.
  - If the distance matches the feeding length, proceed to Step 7.
7. Refer to Chapter 1 "**Media feed adjustment steps**" P. 44 and select " **PF Adjust 5: Micro Print**" on the front panel.
  - Check the pattern and micro adjustment value. In the pattern, look for a place that has least white lines or overlapping in images. The number printed below the adequate pattern is the micro adjustment value.

### Note

- Warm up the heater before printing the Confirm and Adjustment patterns.  
"Skip Heater Warm Up? No" is displayed on the front panel.
- You can start printing while the printer is warming up.
  -  "**Starting printing during warming up**" P. 56

8. Enter the micro adjustment value according to the printing result in Step 7.

## When you know the adjustment value (when changing the media or for similar operations)

1. Enter the adjustment value for " **PF Adjust 6: Micro Change**".
2. Select whether you wish to print a confirm pattern and complete the setup.

## PF Adjust 1: Auto



\*\* : PF Adjust 1

Auto

When the menu on the left appears, tap  (Enter).

The printer will automatically perform a PF adjustment.

### Note

- After automatic PF adjustment is performed, the micro change value will be automatically updated.  
 ["PF Adjust 6: Micro Change" P. 85](#)
- After automatic PF adjustment is performed, the initial change value might be reset.  
 ["PF Adjust 3: Initial Change" P. 84](#)

## PF Adjust 2: Initial Print

\*\* : PF Adjust 2

Initial Print

Performs Initial Print. Enter the "Feed Length" and tap  (Enter).

Setting values

\*\* : Initial Print :

Feed Length: 250 mm

100 mm to <250 mm> to 500 mm

<> indicates the initial value.

- After the initial adjustment printing, cut the media.
- With a ruler, measure the length between " + " in the pattern.  
In the example below, the measured place is shown in orange dotted lines and arrows.

### Note

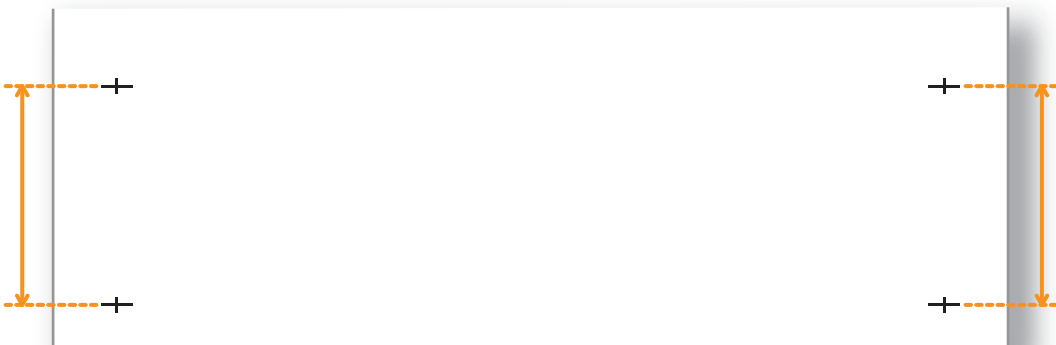

The length of media that is fed (feeding length) for initial adjustment printing is normally set at 250 mm. If you increase the feeding length, the accuracy of the Media feed adjustment improves.

To change the feeding length, tap  or  on the front panel and change the set value.



### PF Adjust 3: Initial Change

\*\* : PF Adjust 3  
Initial Change

Use  or  to enter the adjustment value, and tap  (Enter).

#### Setting values

\*\* : Initial Change :  
Init. : 250.0 mm / 250 mm

You can set a value that is between +50 mm and -50 mm of the feed length configured in "Initial Print".

### PF Adjust 4: Confirm Print

\*\* : PF Adjust 4  
Confirm Print

Performs Confirm Print.

Enter the "Feed Length" and tap  (Enter).

#### Setting values

\*\* : Initial Print :  
Feed Length: 250 mm

100 mm to <250 mm> to 500 mm  
<> indicates the initial value.

- After the confirmation adjustment printing, cut the media.
- With a ruler, measure the length between " + " in the pattern. In the example below, the measured place is shown in orange dotted lines and arrows (the orange parts are not actually printed).
- If the measured length does not match the feeding length, re-correct with [PF Adjust 2: Initial Print](#).
- If the measured length matches the feeding length, proceed to [PF Adjust 5: Micro Print](#).

#### Note

The length of media that is fed (feeding length) for initial adjustment printing is normally set at 250 mm. If you increase the feeding length, the accuracy of the Media feed adjustment improves.

To change the feeding length, tap  or  on the front panel and change the set value.

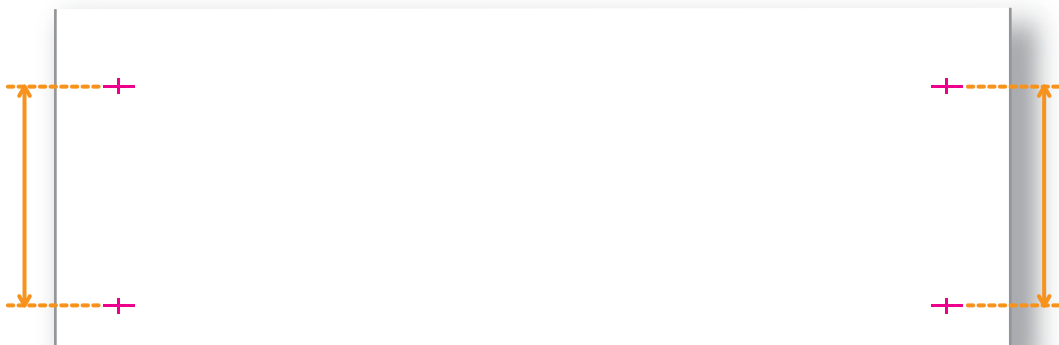

## PF Adjust 5: Micro Print

\*\* : PF Adjust 5

Micro Print

Performs Micro adjustment Print.

Enter the appropriate micro adjustment value according to the print result.

- Observe the pattern and verify the micro adjustment value. In the pattern, look for a place that has least white lines or overlapping in images. The number printed below the pattern is the micro adjustment value. Enter the micro adjustment value according to the print result.

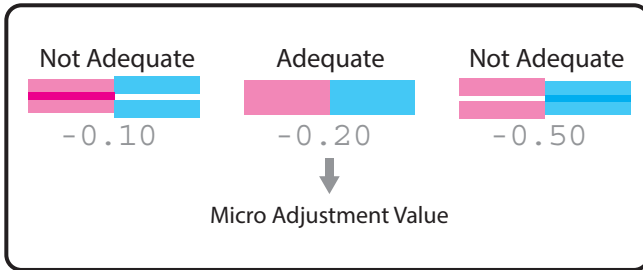

Note



Once an appropriate micro adjustment value has been saved, the value will be the baseline value from the next time to be printed in the center of the pattern.

For example, if you have entered “-0.20” and print a micro adjustment pattern, values printed below block pattern will be changed to (from left) +1.00, +0.60, +0.30, 0.00, -0.20 (baseline value), -0.30, -0.40, -0.70, -1.00, -1.40.

## PF Adjust 6: Micro Change

\*\* : PF Adjust 6

Micro Change

Use  or  to enter the adjustment value, and tap  (Enter).

Select whether you wish to perform confirmation print and complete the setup.

Setting values

\*\* : Micro :  
(-5 - 5)

0.00%



-5.00% to <0.00%> to 5.00%

<> indicates the initial value.

## \*\*>4: Preheater

Type \*\*: 4  
Preheater

Sets up Preheater.

Use  or  to enter the value, and tap  (Enter).

### Setting values



\*\* : Preheater :  
(30 - 50)                      30°C

Off / <30°C> to 50 °C  
<> indicates the initial value.

## \*\*>5: Platen Heater

Type \*\*: 5  
Platen Heater

Sets up Platen Heater.

Use  or  to enter the value, and tap  (Enter).

### Setting values



\*\* : Platen Heater :  
(30 - 50)                      30°C

Off / <30°C> to 50 °C  
<> indicates the initial value.

## \*\*>6: Dryer

Type \*\*: 6  
Dryer

Sets up Dryer.

Use  or  to enter the value, and tap  (Enter).

### Setting values

\*\* : Dryer :  
(30 - 50)                      30°C

Off / <30°C> to 50 °C  
<> indicates the initial value.

### CAUTION



The message "Warming up" appears while the heater is functioning.



**While "Warming Up" is displayed, do not touch Media guide.**

You could burn yourself.

## \*\*>7: Vacuum Fan

Type \*\*: 7  
Vacuum Fan

Selects the vacuum level.

Use  or  to select the value, and tap  (Enter).

- If you are using a thin or delicate media and there is risk of it wrinkling due to the fan, set a lower value for the fan.

### Setting values



\*\* : Vacuum Fan :  
High

Off / Low / Medium / <High> / Ex High  
<> indicates the initial value.

## \*\*>8: Thickness

Type \*\*: 8  
Thickness

Sets the thickness of the media you are using.

Use  or  to enter the value, and tap  (Enter).

### Setting values

\*\* : Thickness :  
(80 - 1300) 170 µm

80 µm to <170 µm> to 1,300 µm  
<> indicates the initial value.

### Note

- This menu is to automatically adjust print quality to a certain extent. If you want to improve print quality, manually adjust it.

 **\*\*>2: Adjust Print" P. 75**

- If you have adjusted the print settings, you do not need to configure the thickness of the media in this menu.

## \*\*>9: Copy User Type

Type \*\*: 9  
Copy User Type

This is for copying the currently selected User Type setting into another User Type.

The items that will be copied are:

- Settings for "Print Mode", "Effect"
- Adjustment values for "Adjust Print", "PF Adjust"
- Settings for "Preheater", "Platen Heater", "Dryer", and "Thickness"

### Setting values

\*\* : UserCopy :  
Type \*\* -> 1

\*\* : UserCopy :  
Type \*\* -> ALL

Here you can select the User Type to copy the settings into.

If you select ALL, the settings will be copied into all the User Type.

## Setup 2: Spitting

### Setup 2 Spitting

Sets up the spitting operation while printing.

The display will shift to setting of the pass count only if "On" is set for "Spitting".

#### Setting values



Perform the spitting operation on Spitting box located on the origin side for every shuttle.

This is the initially set value.



Perform the spitting operation on the page margins. The printing speed will be improved since the number of time to return to Spitting box is reduced.



Spitting operation is not performed.

### Note

- Spitting is a maintenance operation for preventing clogging of the print head's nozzles. It consumes ink.
- When Spitting is set to "Off", nozzles will become easily clogged because spitting is not performed. In such a case, print quality cannot be guaranteed.
- When the spitting setting is "On Media", the maximum printable media width becomes 16 mm shorter. Therefore, the side margins become the value that you have set in Side Margin menu +8 mm.

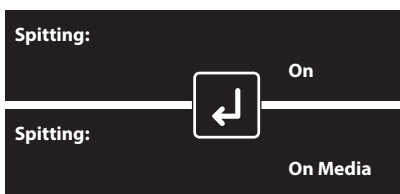

 ["Setup 3: Side Margin" P. 89](#)

## Pass Count menu



This is for setting the interval at which the print head will carry out spitting operation.

The head will carry out spitting operation every time it completes the number of passes that you set here.

Use  or  to enter the value, and tap  (Enter).

#### Setting values



1 cnt/<2 cnt> to 999 cnt

<> indicates the initial value.

### Important!

**If larger count is selected, the printing time will be faster, but it will increase the chance of nozzle clogging. In such a case, print quality cannot be guaranteed.**



## <Example of spitting operation>

| Spitting setting | Pass Count setting | Operation   |
|------------------|--------------------|---|
| On               | 1 cnt              | Perform the spitting operation on Spitting box every time Print head returns to the origin position. Spitting operation is not performed over the media.  |
| On               | 5 cnt              | Performs the spitting operation on Spitting box on the origin side every five times Print head returns to the origin position. Spitting operation is not performed over the media.  |
| On Media         | 1 cnt              | Performs the spitting operation on Spitting box on the origin side every time Print head returns to the origin position. Perform the spitting operation on Spitting box every time Print head returns to the origin position.       |
| On Media         | 5 cnt              | Performs the spitting operation on Spitting box on the origin side every five times Print head returns to the origin position. Perform the spitting operation on Spitting box every time Print head returns to the origin position. |
| Off              | —                  | Spitting is not performed on Spitting box or the media.   |

## Setup 3: Side Margin

### Setup 3 Side Margin

Set up the right and left margins (side margins) while printing.

Use  or  to enter the value, and tap  (Enter).

#### Setting values

Side Margin:  
(5 - 25)                      5 mm

<5 mm> to 25 mm

<> indicates the initial value.

### Important!

**In the default setting, the printer starts printing with 5 mm margin on the sides.**

**Set the side margin to 10mm or more according to the following procedure because the overlapping part of the edge holder and media may be stained with ink.**

### Note

- When the "Spitting menu" is set to "On Media", the maximum printable media width becomes 16 mm shorter. Therefore, the side margins become the value that you have set in Side Margin menu +8 mm.

 ["Setup 2: Spitting" P. 88](#)

## Setup 4: Media Initial

### Setup 4 Media Initial

Sets whether to detect the media width while initializing the media.

#### Setting values

|   |  |
|---|--|
| <b>Media Initial:</b><br><b>Off</b>           | The media will not be detected.  |
| <b>Media Initial:</b><br><b>Top&amp;Width</b> | Detect the media width and edge while initializing the media.                            |
| <b>Media Initial:</b><br><b>Width</b>         | Detect the media width while initializing the media.<br>This is the initially set value. |





#### Note

When "Media Initial menu" is set to "Off", set the media width of the current media in Media Width menu.

## Setup 5: Media Width

### Setup 5 Media Width

Sets the width of the current media when the "Media Initial menu" is set to "Off". When the "Media Initial menu" is set to "Width", the detected media width will be displayed.

Use  or  to enter the value, and tap  (Enter).

#### Setting values

|  |   |
|--|---|
| <b>Media Width:</b><br>(210 - 1625) <b>1000 mm</b> | 210 mm to <1,000 mm> to 1,625 mm<br><> indicates the initial value. |
|--|---|

## Setup 6: Output Mode

### Setup 6 Output Mode

Sets how the media is handled after printing.

#### Setting values

|                          |  |
|--------------------------|--|
| Output Mode:<br>Off      | The Take-up Unit will not be used.<br>This is the initially set value. |
| Output Mode:<br>Take Up  | Set when using the Take-up Unit.                                       |
| Output Mode:<br>Auto Cut | Set when cutting the media<br>automatically.                           |

 ["Setup 7: Method of Cut" P. 92](#)

### When the "Output Mode" is set to "Take Up"





When the "Output Mode" is set to "Take up", the menu is shifted to "Page Gap".  
In the "Page Gap menu", you can change the margin setting between images.

#### Setting values

|                     |   |
|---------------------|---|
| Page Gap:<br>Normal | The default margin setting between<br>images will be applied.<br>This is the initially set value. |
| Page Gap:<br>Narrow | The margin setting between images is<br>smaller than Normal.                                      |

After setting the Page Gap, sets the Ink drying time.

Use  or  to enter the value, and tap  (Enter).



#### Setting values

|   |  |
|---|--|
| InkDryTimer:<br>(0 sec - 60 min)      0 sec | <0 sec> to 60 min<br><> indicates the initial value. |
|---|--|

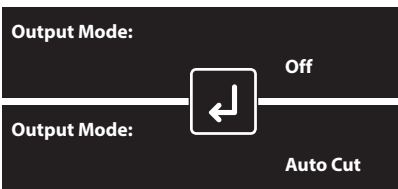
### When the "Output Mode" is set to "Off" or "Auto Cut"



Sets the ink drying time.

Use  or  to enter the value, and tap  (Enter).

#### Setting values

|   |  |
|---|--|
| InkDryTimer:<br>(0 sec - 60 min)      0 sec | <0 sec> to 60 min<br><> indicates the initial value. |
|---|--|

## Setup 7: Method of Cut

### Setup 7 Method of Cut

Sets the media cutting operation after printing.

#### Setting values

Method of Cut:

Single Cut - 2 steps

Cut with fewer steps than "Single Cut - 3 steps".  
Suitable for media with narrow width.

Method of Cut:

Single Cut - 3 steps

Normal cutting method.  
This is the initially set value.

Method of Cut:

Double Cut - 2 steps



Set when unable to cut with "Single Cut - 2 steps".  
Suitable for media with narrow width.

Method of Cut:

Double Cut - 3 steps

Set when unable to cut with "Single Cut - 3 steps".

#### Note

- When the media detection is set to "Off", the media cannot be cut automatically.  
 ["Setup 4: Media Initial" P. 90](#)
- Some media may not be cut (cannot be cut at all or cannot be cut finely). In such a case, set the "Output Mode menu" to "Off" and cut the media manually.  
 ["Setup 6: Output Mode" P. 91](#)

## Cut Pressure menu

Method of Cut:

Single Cut - 3 steps



Sets the media cutting pressure for the cutting operation.

#### Setting values

Cut Pressure:

Low

Cut the media at low pressure.  
Suitable for thin media or if the "High" pressure setting is too strong.





Cut Pressure:

High

Normal cutting pressure.  
This is the initially set value.

## Setup 8: Origin

### Setup 8 Origin

- Sets the print start position (origin) on the media.  
If you want to change the print start position to print an image on the blank space of the media, use this menu.
-  / : Change the print start position (origin) in the PF (media feeding) direction.
-  / : Change the print start position (origin) in the CR (carriage traveling) direction.
- Tap  (Enter) to confirm the setting.

#### Setting values

Origin:  
PF: -15000      CR: 1405

PF (media feeding direction):

-15,000 mm to 15,000 mm

CR (carriage traveling direction)

0 mm to 1,405 mm (maximum setting range varies by width of media being loaded).

Origin:  
PF: 0      CR: 0

Confirm Position  
End      ->      Enter

When the message on the left appears, tap



(Enter) to end the origin settings.

The arrow mark on the origin label shows the current print start position in CR direction.

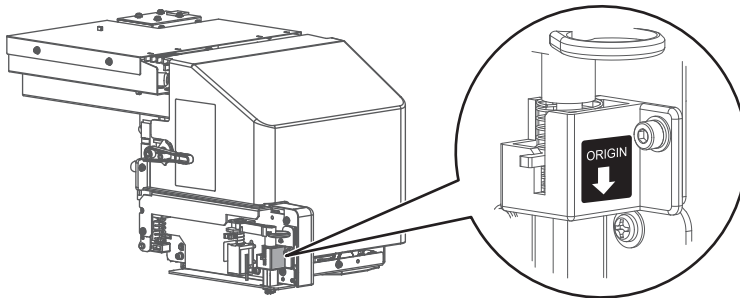

#### Note

- Depending on the set value of the side margin, the maximum set value of CR (print head transferring distance) decreases.

 ["Setup 3: Side Margin" P. 89](#)

- The right side margin will be the following sum depending on the setting.

CR of Origin menu + 8 mm (when the spitting is set to On Media) + Value set in Side Margin menu.

 ["Setup 2: Spitting" P. 88](#), ["Setup 3: Side Margin" P. 89](#)

## Setup 9: Prevent Stick menu

### Setup 9 Prevent Stick

Sets up to prevent media from sticking when printing starts.

#### Setting values

Prevent Stick: Off

The stick-prevent operation is not performed.  
This is the initially set value.

Prevent Stick: On

The stick-prevent operation is performed.  
Feed the media back and forth to prevent from sticking.



#### Note

When the "Output Mode menu" is set to "Take-up", the setting for the "Prevent Stick menu" is disabled.

["Setup 6: Output Mode" P. 91](#)

## Setup 10: Standby Heating

### Setup 10 Standby Heating

Sets the time to preheat Heater while the printer is in the standby mode.  
When the preset time has passed, each Heater turns Off.

Use or to enter the value, and tap (Enter).

#### Setting values

Standby Heating:  
(10 - 60) 60 min

10 min to <60 min>  
<> indicates the initial value.

## Setup 11: Head Travel

### Setup 11 Head Travel

Sets up the range that Print head moves while printing.

#### Setting values

Head Travel: Data

Print head moves the range of the print data width.

Head Travel: Machine

Print head moves from origin to the maximum printable media width.



Head Travel: Media

Print head shifts within the media width.  
This is the initially set value.

## Setup 12: Multi Strike

### Setup 12 Multi Strike

Sets up the overwrite count per line.

Use  or  to enter the value, and tap  (Enter).

#### Setting values

Multi Strike:  
(1 - 9) 1 cnt



<1 cnt> to 9 cnt

<> indicates the initial value.

## Setup 13: Strike Wait

### Setup 13 Strike Wait

Sets up the waiting time while overwrite printing.

Use  or  to enter the value, and tap  (Enter).

#### Setting values

Strike Wait:  
(0.0 - 5.0) 0.0 sec

<0.0 sec> to 5.0 sec

<> indicates the initial value.

## Setup 14: Slant Check

### Setup 14 Slant Check

Sets up slanting detection during media loading.

#### Setting values

Media Slant:  
Off

Slant Check is not performed.

Media Slant:  
On

Slant Check is performed.  
This is the initially set value.

## Setup 15: Auto Cleaning

### Setup 15 Auto Cleaning

Configure the settings for the auto cleaning operation.

#### Submenus

Auto Cleaning 1  
Standby Mode

 [Standby Mode menu](#)

Auto Cleaning 2  
While Printing

 [While Printing menu](#)

Auto Cleaning 3  
Before Print

 [Before Print menu](#)

### Standby Mode menu

#### Auto Cleaning 1 Standby Mode

Choose the auto cleaning mode and timer to be performed while in standby mode.

#### Setting values

Cleaning Type:

Normal

Off / <Spitting> / Short / Normal / Long  
<> indicates the initial value.

### When the cleaning type is set to other than Off

Cleaning Type:

Short



If the cleaning type is set to Short, Normal, or Long, the display goes to the Cleaning Interval setting to set the timer for auto cleaning while in standby mode.

#### Setting values

Cleaning Interval:

(10 - 1440)

360 min

10 min to <360 min> to 1,440 min  
<> indicates the initial value.

#### Note

- The "Cleaning Interval" setting in "Standby Mode" includes the time the power is off.
- If the time set in "Cleaning Interval" passes while the power is off, cleaning will be performed the next time the power is turned on.

## While Printing menu

Auto Cleaning 2  
While Printing

Choose the auto cleaning mode and timer to be performed while printing.

### Setting values

Cleaning Type: Off

<Off> / Short / Normal / Long  
<> indicates the initial value.

## When the cleaning type is set to other than Off

Cleaning Type: Short



If the cleaning type is set to Short, Normal, or Long, the display goes to the Cleaning Interval setting to set the timer for auto cleaning while in printing.

### Setting values

Cleaning Interval:  
(5 - 180) 5 min

5 min to <180 min>  
<> indicates the initial value.

## Before Print menu

Auto Cleaning 3  
Before Print

Choose the auto cleaning mode to be performed before printing.

### Setting values

Cleaning Type: Off

<Off> / Short / Normal / Long  
<> indicates the initial value.

## Setup 16: Exhaust Fan

Setup 16  
Exhaust Fan

Sets up Exhaust fan operation.

Ventilates the inside of the printer to stabilize the parts performance. It also decreases the contamination by ink mist inside the printer.

We recommend that you use Exhaust fan, especially when printing for a long time.

### Setting values

Exhaust Fan: Off

Turn Off Exhaust fan.

Exhaust Fan: Low

Start Exhaust fan at Low.  
This is the initially set value.

Exhaust Fan: High

Start Exhaust fan at High.

## Setup 17: Longstore

Setup 17  
Longstore

Wash Print head with the cleaning fluid.

---

### Submenu

---

Longstore  
Start -> Enter

Wash Print head with the cleaning fluid.  
Tap [Enter] to perform head cleaning.

 ["Long-term storage" P. 169](#)



**Be sure to use the designated cleaning bag.**

## Setup 18: Initialization

Setup 18  
Initialization

Restore the printer settings to the factory default.

---

### Setting values

---

Initialization:  
ALL

For initializing the settings of all the menus.

Initialization:  
UserType

Initializes the settings in the User Type menu.

Initialization:  
Except UserType

Initializes the settings other than the ones in the User Type menu.

## Setup 19: Header Dump

### Setup 19 Header Dump

Sets whether to print the following information when printing.

- Data header
- Data dot number (printed only when Header dump setting is "On")
- Printing date and time
- Printer serial number
- Firmware version
- Receiving time (printed only when Header dump setting is "Dump")
- Receiving size (printed only when Header dump setting is "Dump")

---

#### Setting values

---

|                    |   |
|--------------------|---|
| Header Dump: Off   | Dump data is not printed.<br>This is the initially set value.   |
| Header Dump: On    | Dump data is printed after the original image is printed.   |
| Header Dump: Dump  | Prints only dump data.<br>"Data dot number" is not printed.   |
| Header Dump: Print | Prints the last header dump.<br>If no history is available, "No Print Data" will appear on the front panel. |

#### Note

- The data will be useful when contacting technical support.
- Performing printing if the printer is connected to PC, the print settings of RIP soft you are using are printed on data header.

## Setup 20: Head Select

### Setup 20 Head Select

Select a printhead (4-color ink configuration only) and a nozzle line to be used for printing.

You can still print even if some of the print heads malfunction. However, in that case the printing speed will drop.

4-color ink configuration printer:

The Nozzle Line menu appears after you select a printhead from the Single Head menu.

8-color ink configuration printer:

The Nozzle Line menu appears under the Head Select menu. (The Single Head menu is not displayed because this configuration always uses two printheads.)

#### Setting values

Head Select:  
Single Head                      Off

Select this setting to use all the print heads for printing.

This is the initially set value.

(4-color ink configuration only)

Head Select:  
Single Head                      Head 1

Select this setting to use only print head 1 for printing.

(4-color ink configuration only)

Head Select:  
Single Head                      Head 2

Select this setting to use only print head 2 for printing.

(4-color ink configuration only)

(4-color ink configuration printer with Single Head set to "Head1")

Head Select:  
Single Head:  Head1

(8-color ink configuration printer only)

Setup 20  
Head Select

Select a nozzle line to be used for printing.

#### Setting values

Head Select:  
Nozzle Line                      All

Printing is performed with all nozzles.

Head Select:  
Nozzle Line                      Odd

Printing is performed with the odd number nozzle lines only.

Head Select:  
Nozzle Line                      Even

Printing is performed with the even number nozzle lines only.

### Important!

**In case of any problems with the print heads, contact your local MUTOH dealer.**

### Note

- The following test printing or adjustment pattern printing is performed with all nozzle lines even when Nozzle Line is set to "Odd" or "Even":
  - Adjust Print / Head Adjust / PF Adjust / Header Dump / Select Nozzle confirmation pattern / Nozzle Check F / Mode Print / Setup List / Palette
- Nozzle Area Select in Select Nozzle will be restored to "Nozzle All" when the Single Head option is changed.

 **"Setup 20: Head Select" P. 100, "Nozzle Area Select" P. 101**

## Setup 21: Select Nozzle

Setup 21  
Select Nozzle

If missing lines still persist after several attempts of cleaning, you can check the nozzle conditions by printing the nozzle area select patterns and choose only good nozzles for printing.

---

### Setting values

---

Select Nozzle1  
Print

 ["Confirm pattern" P. 102](#)

Select Nozzle2  
Nozzle Area Select

 ["Nozzle Area Select" P. 102](#)

## Nozzle Area Select

Select Nozzle2  
Nozzle Area Select

Goes to the nozzle area select menu.

---

### Submenus

---

Nozzle Area Select:  
Nozzle ALL

<Nozzle All> / Nozzle A to Nozzle F  
<> indicates the initial value.



### Note

- Nozzle Area Select in Select Nozzle will be restored to "Nozzle All" when the Single Head option is changed.

 ["Setup 20: Head Select" P. 100](#), ["Nozzle Area Select" P. 101](#)

## Steps

1. Print the nozzle area select patterns and find the pattern that does not have missing lines.
2. Go to "Nozzle Area Select" and choose the pattern selected in the Step 1.
  - Select "ALL", or one of "A" to "F".

## Confirm pattern



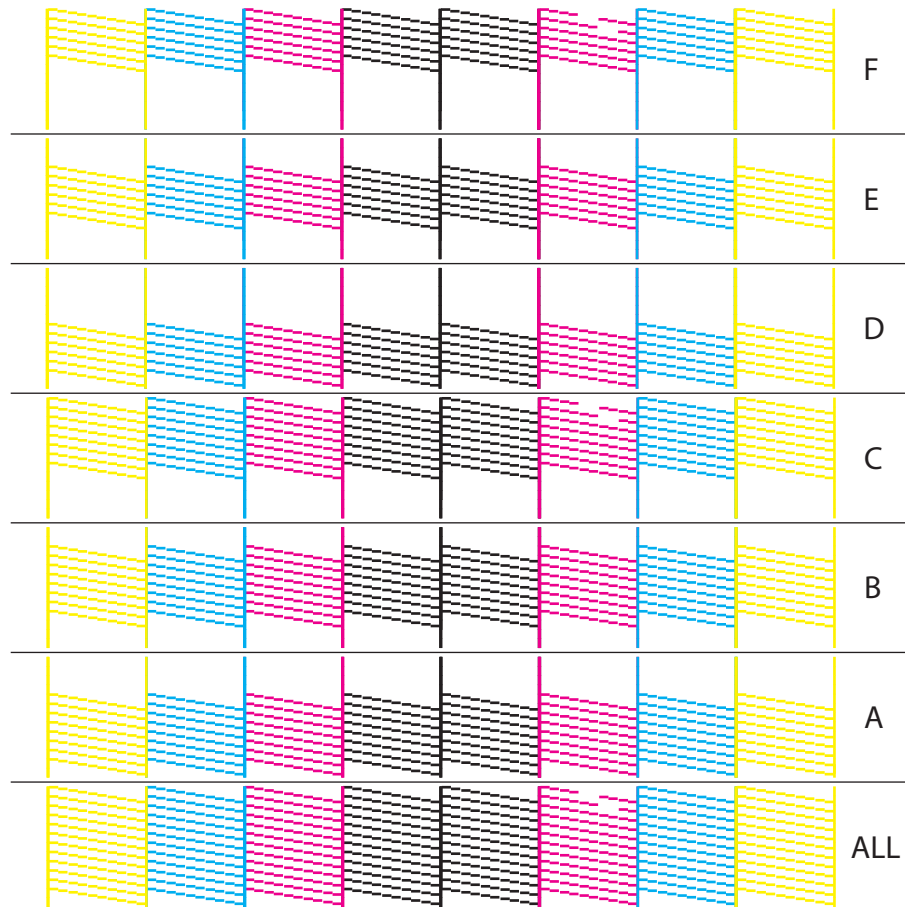

- Tap  (Enter) to carry out printing.
- Look at the print and find the pattern that all the lines appear clean.
- In the example here, the pattern A, pattern B, pattern D and pattern E do not have missing lines.



### Note

The pattern shown above is an example when printed with 4-color configuration.

## Nozzle Area Select

- Tap .
- Use  or  to choose the pattern that does not have missing lines, then tap  (Enter).
- If there is more than one patterns not suffering from missing lines, choose the one that has more nozzles available for printing.
- ALL has the most available nozzles for printing, followed by A to C, and D to F (More ALL > A = B = C > D = E = F Less).
- For example, if the pattern A and pattern D do not suffer from blocked nozzles, you should choose A.

## Setup 22: Heater Control

### Setup 22 Heater Control

Choose the appropriate heater mode for your media being loaded.  
If the media cockling is visible on the print, you can reduce it by selecting the appropriate heater mode.

#### Setting values

Heater Control:

Normal

If you are using the non-heat sensitive media, choose the Normal mode.  
This is the initially set value.

Heater Control:

Fixer

If you want to reduce time to start printing and make media cockling less visible, choose the Fixer mode.

Heater Control:

Dryer

If you are using the take-up unit and want to make media cockling less visible without reducing drying performance, choose the Dryer mode.

## Setup 23: Start Feed

### Setup 23 Start Feed

You can change the margin setting between images.

- Value greater than 0: The margin setting between images will be wider than when setting "0".
- Value equal to 0: The default margin setting between images will be applied.
- Value less than 0: The margin setting between images will be smaller than when setting "0".

#### Setting values

Start Feed:

(-10 - 500)

0 mm

-10 mm to <0 mm> to 500.0 mm  
<> indicates the initial value.

#### Note

With take-up system: if you want to set "Start Feed" to below 0, set "Page Gap" to "Narrow".

If not, the Start Feed setting is not reflected properly.

 ["When the "Output Mode" is set to "Take Up" P. 91](#)

## Setup 24: Internal LED Lights

### Setup 24 LED Light

Selects the internal LED lights settings.

The lights help to inspect inside of the printer or your print during printing.

#### Submenus

LED Light: **Auto**

The LED lights automatically turn on while printing, front cover open, initializing media, cutting media, specifying print start position (origin), and feeding media.

The default is set to Auto.

LED Light: **On**

The LED lights are always on. It will turn off while in sleep mode or when the printer is powered off.

LED Light: **Off**

The LED lights are disabled.

## Setup 25: Front Interlace

### Important!

This menu does not appear on 8-color configuration printer.

### Setup 25 Front Interlace

Select to enable or disable the Front Interlace function.

It automatically fine tunes the media feeding amount of the first print swath to improve print quality.

Use the "Auto" setting for normal print job.

In following cases, try with "Off" setting to see if the print quality is improved:

- If the print defect due to nozzle clogging is found on the first print swath of the print.
- If the print quality is clearly different between the first print swath and rest of the area on the print.

#### Submenus

Front Interlace: **Auto**

Automatically enable the Front Interlace function as needed.

The default is set to "Auto".

Front Interlace: **Off**

Disable the Front Interlace function.

### Note



The Front Interlace function is performed in the following cases, even if "Front Interlace" is set to "Off".

- When "Output Mode" is set to "Take Up" and "Page Gap" is set to "Narrow".

 ["When the "Output Mode" is set to "Take Up" P. 91](#)

## Setup 26: Auto Nozzle Check (Requiring the optional drop sensor unit)

### Important!

- To use this function, you need an optional drop sensor unit.  
 [Drop Sensor Unit Operation Manual](#)
- To use the Auto Nozzle Check function, make sure to set the head height to "Low1", "Low2" or "Middle" and attach a black cleaning wiper (normal type).  
This function does not work with the head height "High" setting. Also, Mutoh does not guarantee this function to use with a grey wiper (for head height High) attached.
- If you use the printer in non-recommended environment ([P. 197](#)) or depending on the types of ink being loaded, the following symptom may occur:
  - cleaning is performed every time the printer runs an auto nozzle check.
  - an auto nozzle check takes longer than usual.
  - nozzle clogs persist even after the auto nozzle check has been performed.\*  
\*If it persists, manually run a nozzle check and cleaning.  
 ["Nozzle check" P. 36](#), ["Cleaning" P. 38](#)
- This feature does not guarantee 100 percent prevention of nozzle clogs.

### Setup 26

### Auto Nozzle Check

Select to enable or disable the auto nozzle check function.

In normal nozzle check, you will run a nozzle check print and will check missing lines by eye inspection.

If any nozzle clogs were detected, it will perform an automatic cleaning and will continue printing or will automatically select a print head and/or a nozzle segment that works properly to continue printing.

Tapping the  (Cancel) key while auto nozzle checking will cancel the auto nozzle check.

#### Setting values

Auto Nozzle Check:

Off

Disable the auto nozzle check function.  
The default is set to "Off".

Auto Nozzle Check:

On

The printer runs an auto nozzle check when:

- powering on
- waking up from sleep mode
- performing the first print after the number of print job setting was specified and each time before printing the number of print jobs specified

### Note

- If you switch the auto nozzle check setting to "On" while some nozzles are blocked, the printer will perform cleaning every time it runs an auto nozzle check, resulting in consuming more ink.  
To avoid this, select a nozzle segment that works properly from [Setup 21: Select Nozzle](#) beforehand and then enable the auto nozzle check function.

## When "Auto Nozzle Check" is set to "On"



Note

Normally the detection takes about 3 to 5 minutes, but it may take longer according to the number of clogged nozzles.



Specify the auto nozzle check settings.

### Submenus

Auto Nozzle Check1  
Number of print job

["Set the number of print jobs" P. 106](#)

Auto Nozzle Check2  
Select Nozzle

["Set the Select Nozzle" P. 106](#)

## Set the number of print jobs

Auto Nozzle Check1  
Number of print job

You can specify the auto nozzle check cycle by the number of print jobs performed. When specified, the printer will run an auto nozzle check in the following timing:

- Before performing the first print after this setting was specified.
- Each time before printing the number of jobs specified.

For example) When set to "3 cnt":

the printer will run an auto nozzle check before printing for the first time after "3 cnt" was specified and before printing the third print job. Then an auto nozzle check will be performed every three jobs before printing.

### Setting values

Number of print job:  
1 cnt

Off / <1 cnt> to 30 cnt  
<> indicates the initial value.

## Set the Select Nozzle

Auto Nozzle Check2  
Select Nozzle

In the ON setting, if there is any missing line in the nozzle check print even after 3 cleanings, the printer will automatically select one print head, one nozzle segment, or a combination of one print head and one nozzle segment that works properly to continue printing.

### Setting values

Select Nozzle :  
On

The printer automatically selects one print head and/or one nozzle segment for printing.

This is the initially set value.

["If cleaning could not recover the clogged nozzles" P. 107](#)

Select Nozzle :  
Off

The printer does not automatically make a print head or a nozzle segment selection.

["In case the automatic print head or nozzle segment selection cannot avoid clogged nozzles" P. 107](#)

## The flow of the auto nozzle check

### 1. When an auto nozzle check detected clogged nozzles



If nozzle clogs were detected, the printer will automatically run cleaning to recover the nozzles.

- If you have changed the settings in [Setup 20: Head Select](#), the printer will not perform an auto cleaning on the non-selected print head.

Up to 3 cleanings will be performed.

### 2. If cleaning could not recover the clogged nozzles

When "Head 1" and "Pattern A" are selected:

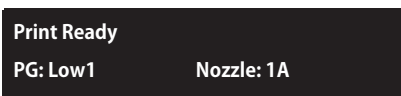

When "Head 2" is selected:

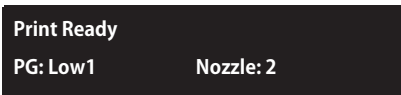

When "Pattern B" is selected:

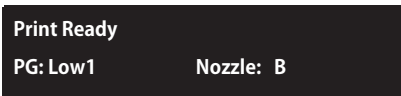

If the nozzle clog is still present after 3 cleanings, the printer will automatically select a print head and/or a nozzle segment that works properly to avoid clogged nozzles for printing.

- While the printer is ready to print, a print head (numeric character) and/or a nozzle segment (alphabetical character) that the printer automatically selected will appear on the operation panel.
- If you have changed the settings in [Setup 20: Head Select](#) and/or [Setup 21: Select Nozzle](#), the length of media will be displayed on the panel.

### 3. In case the automatic print head or nozzle segment selection cannot avoid clogged nozzles

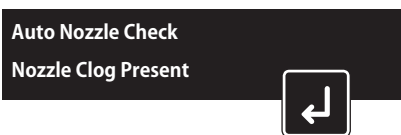

If the printer is unable to select a print head or a nozzle segment that works properly even after 3 cleanings, the message "Auto Nozzle Check Nozzle Clog Present" will appear on the operation panel.

The print job that the nozzle clog was detected will be deleted. Other print jobs sent to the printer will be put on hold.

- You must delete the print jobs currently on hold from the print queue and manually run a nozzle check and cleaning.

 ["Nozzle check" P. 36](#), ["Cleaning" P. 38](#)

Mutoh recommends that you recover the clogged nozzles and then print your job again.

- Tapping  (Enter) key will clear the message and will continue printing while nozzles are still clogged.

## Setup 27: Power Off



Turn off the printer.

 ["Turning the power OFF" P. 24](#)

## Setup 28: Temporary

Setup 28  
Temporary

Displays the menus which have been set to hide in the "Menu4: Menu Option" temporarily.

Tap  (Enter) to return to the previous menu with all set up items displayed.

## Menu 2 : Test Print

### Test Print 1: Nozzle Check

Test Print 1

Nozzle Check

Use this menu to check that the print head and print nozzles you selected can properly print without nozzle clogging and missing or too light lines.

☞ ["Nozzle check steps" P. 37](#)

This menu will print a nozzle check pattern selected from the Head Select menu and Select Nozzle menu.

☞ ["Setup 20: Head Select" P. 100](#)

☞ ["Setup 21: Select Nozzle" P. 101](#)

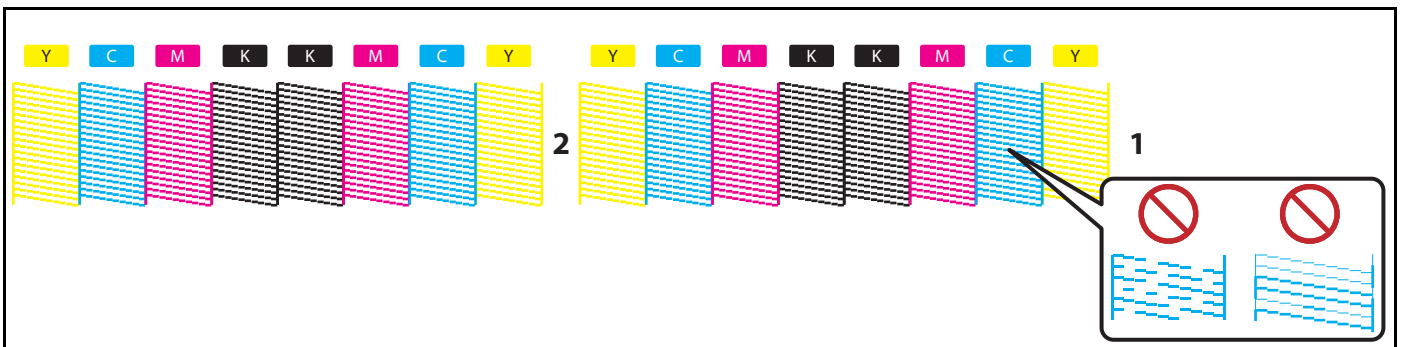

#### Note

- The pattern shown above is an example of 4-color configuration printer with Head Select set to "Off", Nozzle Area Select set to "Nozzle ALL" and Select Nozzle set to "Nozzle All".
- For details of Head Select and Select Nozzle menus, see ["Setup 20: Head Select" P. 100](#) and ["Setup 21: Select Nozzle" P. 101](#).
- The printer information (date and time printed, printer's serial number, firmware version, Head Select setting, Select Nozzle setting) is printed on the nozzle check pattern.

## Test Print 2: Nozzle Check F

Test Print 2

Nozzle Check F

Use this menu to check that the print head and print nozzles you selected can properly print without nozzle clogging and missing or too light lines. This menu will print a nozzle check pattern using all of the nozzles on the print head.

 ["Nozzle check F steps" P. 36](#)

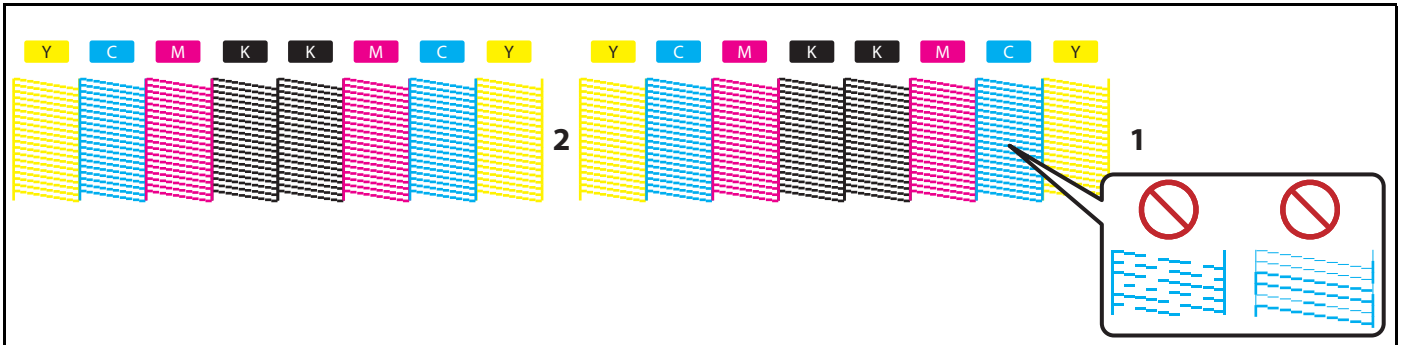

### Note

- The pattern shown above is an example when printed with 4-color configuration.
- The printer information (date and time printed, printer's serial number, firmware version) is printed on the nozzle check pattern.

## Test Print 3: Mode Print

Test Print 3

Mode Print

Mode print can be performed. Used to confirm the following printing conditions.

- Print quality
- Effect
- Setting value for Dryer
- Micro adjustment value for feed correction

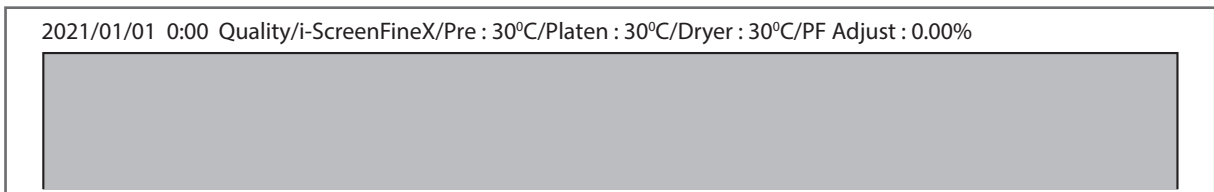



## Test Print 6: Adjust Head

### Test Print 6 Adjust Head

This menu calibrates the dot placement between two print heads installed on this printer.

Tap  to open the submenu.

Align the heads in the following cases:

- If the image quality does not improve after you have used the "Adjust Print" menu.
- When switching to thin media or a type of media where ink drops do not spread.

After executing this menu, be sure to perform the "Adjust Print" function.

If you don't, the image quality during bidirectional printing may drop.

---

#### Submenus

---

##### Adjust Head 1

Standard

Adjustment is performed only for the print mode set by the current User Type. You can make the adjustments more quickly than by selecting "Fine Pattern ALL" in "Custom".

When selecting "Standard" here, you need to use the same print mode settings for the RIP (Raster Image Processor) as the print mode settings for the User Type. Use the same settings for the resolution, pass and printing direction in the RIP print mode as in the print mode for the User Type.

You can also adjust a print mode other than the one used for the current User Type. You can print with an optimal image quality even if the RIP print mode is different from the print mode used for the User Type.

##### Adjust Head 2

Custom

##### Adjust Head 3

Auto

Perform the automatic adjustment using the embedded color sensor.

It helps to reduce time and increase the alignment accuracy.

#### Note

- If print defects (like banding or grainy look) still appear on the print, try an auto calibration again, or go to "Adjust Head1/ Standard" or "Adjust Head2/ Custom" to perform calibration.
- If a roll media starts to cockle during calibration, load the media again.
- "Test Print 6 Adjust Head" requires at least 550 mm printable width. Before printing, make sure that there is sufficient width on the media. If printable width is less than 550 mm, your printer will not perform printing. Printable width on the media can be adjusted by changing CR origin and side margin (left and right side margin) settings.

 ["Setup 5: Media Width" P. 90](#), ["Setup 8: Origin" P. 93](#), ["Setup 3: Side Margin" P. 89](#)

## When "Adjust Head 2 Custom" is selected

Adjust Head 2  
Custom



You can select the adjustment method. Tap  to open the submenu.

When selecting "Fine Pattern X (A to F)", select the option that corresponds to the print mode used for printing.

If the resolution, pass and the printing direction of the RIP print mode differ from the print mode for the User Type, select the fine pattern that is suitable for the RIP.

 ["Adjustment patterns for each print mode" P. 77](#)

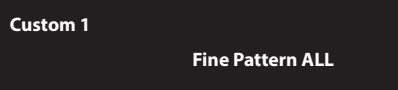
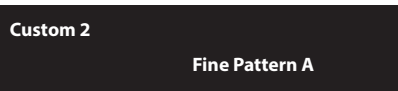
### Submenus

|   |  |
|---|--|
|  | Adjusts all the patterns.                            |
|  | For printing an adjust pattern selected from A to F. |
| ⋮   |  |
|  |  |

## Standard or Custom Adjustment Methods

1. Print the Head adjustment pattern and look for a place in the pattern that has least white lines or overlapping images.
  - If you selected "Adjust Head 2: Custom", select "ALL" or "A" to "F".
  - The number printed under the pattern without alignment errors is the adjustment value.
2. Enter the adjustment value.

### Note

- Warm up the heater before printing the Confirm and Adjustment patterns.  
"Skip Heater Warm Up? No" is displayed on the front panel.
- You can start printing while the printer is warming up.





 ["Starting printing during warming up" P. 56](#)

### CAUTION



**While "Warming Up" is displayed, do not touch Media guide.**  
You could burn yourself.

## Head adjustment pattern

- Press the  (Enter) key to carry out printing. For the Head adjustment pattern, the same patterns will be printed on both sides and center of the media.
- Check the print results and select the number that looks most aligned between 1 and 7.
- Pattern names such as "Pattern D: 4" are shown on the display. Use the  /  key to enter the number of the best-adjusted pattern, and press the  (Enter) key.
- In the case of the picture below, enter "5", so that the display reads "Pattern D: 5".
- If you selected "Head Adj. 2: Custom" and "Fine Pattern ALL," enter the adjustment value for A to F.

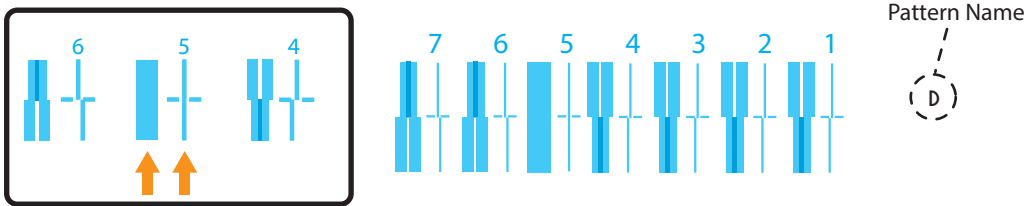

## When "Adjust Head 3 Auto" is selected

Adjust Head 3  
Auto

You can select the adjustment method. Tap  to open the submenu.  
Perform the automatic adjustment using the embedded color sensor.

If the resolution, pass and the printing direction of the RIP print mode differ from the print mode for the User Type, select the fine pattern that is suitable for the RIP.

 ["Adjustment patterns for each print mode" P. 77](#)

### Submenus

Auto 1  
ALL

Perform automatic adjustment for all patterns (A to F) using the color sensor.

Auto 2  
Standard

Perform automatic adjustment for the currently selected print mode using the color sensor (calibrate the same print mode as "Adjust Head1 Standard").



Auto 3  
Adjust Pattern A

Choose the adjustment pattern between A and F for automatic adjustment.

•  
•  
•

Auto 8  
Adjust Pattern F

## Auto Adjustment Method

1. Select the adjustment pattern from "ALL", "Standard", or any specific pattern between "Adjust Pattern A" and "Adjust Pattern F".
  - The selected adjustment pattern is printed.
  - The printer scans the print using the embedded color sensor, then automatically corrects the dot placement.
2. Once successfully completed, the message "Auto Adjust Succeeded End->Enter" will appear on the panel.
  - If failed, the message "Auto Adjust Failed End -> Enter" will appear on the panel.Tap  (Enter) to end the adjustment.
  - Try Auto Adjust again or perform Standard or Custom adjustment.
3. Tap  (Enter) to exit the menu.

### Note

- If failed in the middle of the calibration, the adjustment value for the pattern which has been successfully calibrated will be saved in the printer, but the adjustment value for the pattern which has been failed to calibrate or has not been calibrated yet will not be saved in the printer.
- Warm up the heater before printing the Confirm and Adjustment patterns.  
"Skip Heater Warm Up? No" is displayed on the front panel.
- You can start printing while the printer is warming up.  
 ["Starting printing during warming up" P. 56](#)
- If print defects (like banding or grainy look) still appear on the print, try an auto calibration again, or go to "Adjust Head1/ Standard" or "Adjust Head2/ Custom" to perform calibration.
- If a roll media starts to cockle during calibration, load the media again.

### CAUTION



**While "Warming Up" is displayed, do not touch Media guide.**  
You could burn yourself.

# Menu 3 : Cleaning

Menu 3  
Cleaning

Tap [Enter] to select the print heads you wish to clean.

If nozzle clogging is occurred in specific print head, select the print head that you want to perform cleaning. In this way, you can reduce ink waste.

---

## Setting values

Select Print Head

ALL

Select this setting to clean all the print heads.

Select Print Head

Head 1

Select this setting to clean only print head 1.

Select Print Head

Head 2

Select this setting to clean only print head 2.

Select Print Head



ALL

Select the cleaning type.

---

## Setting values

Cleaning Type1

Short

Consumes less ink than Normal cleaning.

Cleaning Type2

Normal

Conduct nozzle check before and after printing, and use when nozzle clogging is found.

Cleaning Type3

Long

Consumes more ink than Normal cleaning. When nozzle clogging still occurs after Normal cleaning, conduct Long cleaning.

Cleaning Type4

Little Charge

Though much better cleaning results can be expected than Long cleaning, it consumes a large amount of ink.

Cleaning Type5

Initial Charge

Gives a rather higher cleaning effect than "LittleCharge", but also consumes rather more ink.



Note

"InitialCharge" is available only when the Select Print Head menu is set to "ALL".

## Menu 4 : Menu Option

You can choose whether to display the menus in “Menu 1: Setup”.

Choose whether you wish to display a menu by tapping  (Enter).

[\*]= the item will be displayed

[ ]= the item will not be displayed

Menu Option 1: [\*]  
User Type

Displays the “User Type menu”.  
The initial value is [\*].

Menu Option 2: [\*]  
Spitting

Displays the “Spitting menu”.  
The initial value is [\*].

Menu Option 3: [\*]  
Side Margin

Displays the “Side Margin menu”.  
The initial value is [\*].

~  
~  
~

~  
~  
~

Menu Option 28:  
ALL On

If you tap  (Enter), all the items in Menu Option will be marked with a [\*]  
(displayed).

Menu Option 29:  
ALL Off

If you tap  (Enter), all the items in Menu Option will be marked with a [ ]  
(not displayed).

# Menu 5 : System Info.

## Menu 5 System Info.

Display the system information on your printer.

Version  
Ver. M / C            X.XX / X.XX

Displays firmware versions that are currently installed on your printer.

Printer Model  
\*\*\*\*\*

Displays the model name of your printer.

Serial Number  
\*\*\*\*\*

Displays your printer's serial number.

Ink Type  
MS41

Displays the type of ink in use.

Total Print Area  
\*\*\*\*\* m<sup>2</sup>

Displays total printed area in the printer since the purchase.  
This information may be used for reference for maintenance.

Ink Status  
Enter

Tapping (  (Enter) key) will display ink level in the cartridges.

 [Ink Status](#)

Life Times  
Enter

Tapping (  (Enter) key) will display lifetime of each printer part.

 [Life Times](#)

## Ink Status

1 2 3 4 :            100 / 90 / 90 / 80  
5 6 7 8 :            100 / 90 / 90 / 80

Displays the percentage of ink level in each ink bag.

To identify the ink slots corresponding to each ink color shown here, see "[Main components of your printer](#)" P. 9.

### Note

- To display various information of Ink, use genuine ink and S/C cards.  
If Ink bags other than genuine Ink bags are used, ink status will not be displayed correctly.
- If it is blinking at 10%, smartchip recovery is being performed on the corresponding S/C card.  
 "[Smartchip recovery](#)" P. 183

# Life Times

Life Times

Enter

Displays the operational life time of each part.

- The lifetime of each part is indicated by the asterisks (Maximum 5 asterisks: 100% left). As the part deteriorates, the number of asterisks decreases one by one (20%).
- The part should be replaced when all of the asterisks have disappeared and "Change" is displayed.  
Contact your local MUTOH dealer to ask for replacing parts.
- After "Change" appears, "Life Times [Pump]" or a similar message will be displayed when you are not in this menu.

You can delete this message by pressing the  (Cancel) key.

Life Times  
Head1: E\*\*\* F

Displays the service life for the print head 1.

The service life in this case is at 60%.

Life Times  
Head2: E\*\*\* F

Displays the service life for the print head 2.

The service life in this case is at 60%.

Life Times  
Pump1: E\*\*\* F

Displays the service life for the pump 1.

The service life in this case is at 60%.

Life Times  
Pump2: E\*\*\* F

Displays the service life for the pump 2.

The service life in this case is at 60%.

Life Times  
CR Motor: Change

Displays the service life for the CR motor.

The service life of the component in this case is over.

Have the component replaced.

Life Times  
PF motor: E\*\*\*\* F

Displays the service life for the PF motor.

The service life in this case is at 80%.

# Menu 6 : Sleep Mode

## Menu 6 Sleep Mode

Start Sleep Mode and set the head cleaning interval during Sleep Mode.

### Submenu

Sleep Mode 1  
Cleaning Setting

 [Sleep Mode 1: Cleaning Setting](#)

Sleep Mode 2  
Auto Sleep Timer

 [Sleep Mode 2: Auto Sleep Timer](#)

Sleep Mode 3  
Start

 [Sleep Mode 3: Start](#)

## Sleep Mode 1: Cleaning Setting

### Sleep Mode 1 Cleaning Setting

Set the timer to perform the head cleaning while in sleep mode.

### Setting values

Cleaning Type:

Short

< Short > / Normal / Long

<> indicates the initial value.

Tap



(Enter) to confirm the setting and the display goes to the Cleaning Timer setting.

Cleaning Timer:

(12h - 7Day)

7 Day

12h, 1 / 2 / 3 / 4 / 5 / 6 / <7> day

<> indicates the initial value.

## Sleep Mode 2: Auto Sleep Timer

### Sleep Mode 2 Auto Sleep Timer

Set the timer to automatically enter sleep mode if no printing is performed for certain period.

### Setting values

Auto Sleep Timer

(4 - 24)

4h

<4> / 8 / 12 / 24h

<> indicates the initial value.

## Sleep Mode 3: Start

Sleep Mode 3  
Start

Put the printer into sleep mode.

- Tap .
- "Sleep Mode Start -> Enter" is displayed.

Tap  (Enter).

- "In Sleep Mode Wake up -> Enter" is displayed.  
The sleep mode will start.

- To exit the sleep mode, tap  (Enter).

### Important!

**During Sleep Mode, even if the set amount of time has passed, print-head cleaning is not performed under the following circumstances.**

- **When the front cover is open.**
- **When the maintenance cover is open.**
- **The pressure rollers is released.**
- **The waste ink tank is full.**
- **The ink bag case has been removed.**
- **The S/C card has been removed.**
- **The inserted S/C card is not the genuine S/C card, etc.**

**If one of the above conditions occurs during Head cleaning, cleaning is stopped.**

**When the printer returns to a normal state, Head cleaning is restarted.**

# Menu 7 : Initial Settings

## Initial Settings 1: Language

Initial Settings1  
Language

Choose the language of the front panel from the following selection.

---

### Setting values

---

Language: English

Default setting.

Language: Dutch

Language: Spanish

Language: French

Language: Italian

Language: Portuguese

Language: German

Language: Japanese

## Initial Settings 2: Temperature

Initial Settings2  
Temperature

Choose the unit of the temperature displayed on the front panel.

---

### Setting values

---

Temperature: Celsius [°C]

Displays the temperature in Celsius.  
This is the initially set value.

Temperature: Fahrenheit [°F]

Displays the temperature in Fahrenheit.

## Initial Settings 3: Length

### Initial Settings3 Length

Choose the unit of the length displayed on the front panel.

#### Setting values

Length: mm

Displays the length in millimeters (mm).  
This is the initially set value.





Length: inch

Displays the length in inches (inch).

## Initial Settings 4: IP Address

### Initial Settings4 IP Address

Set the IP address of the printer.

- Use  to increase a digit.
- Use  to decrease a digit.
- Use  to move the cursor to the previous digit.
- Use  to move the cursor to the next digit.

Tap  (Enter) after entering each digit.

#### Setting values

IP Address:  
192. 168. 1. 253

0.0.0.0 to <192.168.1.253> to  
255.255.255.255  
<> indicates the initial value.







#### Note

Be sure to set the IP address, Subnet mask, and Gateway after consulting the network administrator.

## Initial Settings 5: Subnet Mask

### Initial Settings5 Subnet Mask

Set the subnet mask of the printer.

- Use  to increase a setting value.
- Use  to decrease a setting value.
- Use  to move the cursor to the previous digit.
- Use  to move the cursor to the next digit.

Tap  (Enter) after entering each digit.

#### Setting values





Subnet Mask:  
255. 255. 255. 0

0.0.0.0 to <255.255.255.0> to  
255.255.255.255  
<> indicates the initial value.

## Initial Settings 6: Gateway

### Initial Settings6 Gateway

Set the gateway.

- Use  to increase a setting value.
- Use  to decrease a setting value.
- Use  to move the cursor to the previous digit.
- Use  to move the cursor to the next digit.

Tap  (Enter) after entering each digit.

---

#### Setting values

---

Gateway:  
192. 168. 1. 254

0.0.0.0 to <192.168.1.254> to  
255.255.255.255  
<> indicates the initial value.

## Initial Settings 7: Alert Buzzer

### Initial Settings7 Alert Buzzer

Selects how to turn off the printer beep sound when an error occurs.

For unattended printing, you can select "Off" setting to avoid continuous buzzer beep.

---

#### Setting values

---

Alert Buzzer:  
On

Press any key on the front panel to turn off  
beep sound.  
This is the initially set value.

Alert Buzzer:  
Off

After several beeps, the printer  
automatically turns off beep sound.

## Menu 8 : Job Status

### Menu 8 Job Status

Various information of previous print will be displayed.

|                       |           |
|-----------------------|-----------|
| Job Status<br>Status: | Completed |
|-----------------------|-----------|

Displays if the print is completed.

- When the print is completed: [Completed]
- When the print is canceled: [Canceled]

|                           |         |
|---------------------------|---------|
| Job Status<br>ToDoLength: | XXX.X m |
|---------------------------|---------|

The total length of print data (media feeding direction) will be displayed.

|                     |         |
|---------------------|---------|
| Job Status<br>Done: | XXX.X m |
|---------------------|---------|

The printed length will be displayed.

|                       |         |
|-----------------------|---------|
| Job Status<br>Remain: | XXX.X m |
|-----------------------|---------|

The remaining length of print data will be displayed.

### Note

- The values displayed in this function are just standard values, not guarantee the accuracy.
- If the print data includes no length data, all information will be displayed as "0".
- This function is to check the information of print data with the print operation is completed. For the details on data while printing, please refer to the "[Menu 7: Job Status](#)" P. 62.

# Menu 9 : Roll Length Manage

## Menu 9 Roll Length Manage

Before replacing with another roll media, you can print the remaining roll length information on the roll media.

This information can be printed with a code that your printer can read. The next time when the roll media is loaded, your printer will read the code and will automatically specify the Roll Length settings.

### Submenu

Roll Length Manage1  
Print

 ["Roll Length Manage1: Print" P. 127](#)

Roll Length Manage2  
Simple Print

 ["Roll Length Manage2: Simple Print" P. 127](#)

Roll Length Manage3  
Scan

 ["Roll Length Manage3: Scan" P. 128](#)

Roll Length Manage4  
Roll Length

 ["Roll Length Manage4: Roll Length" P. 129](#)

Roll Length Manage5  
Auto Scan

 ["Roll Length Manage5: Auto Scan" P. 130](#)

Roll Length Manage6  
Auto Print

 ["Roll Length Manage6: Auto Print" P. 131](#)

### Note

- "Roll Length Manage 1: Print" or "Roll Length Manage 2: Simple Print" requires at least 400 mm printable width. Before printing, make sure that there is sufficient width on the media. If printable width is less than 400 mm, your printer will not perform printing. Printable width on the media can be adjusted by changing CR origin and side margin (left and right side margin) settings.

 ["Setup 5: Media Width" P. 90](#), ["Setup 8: Origin" P. 93](#), ["Setup 3: Side Margin" P. 89](#)





- The message "Cannot Operate ... " may appear when the submenu is selected. For the content of error and remedies, see the following section.

 ["Error message display and remedies" P. 180](#)

## Roll Length Manage1: Print

Print the remaining length management information with text and code on the roll media.

Roll Length Manage1  
Print

- Tap .
- "Do you want to cut?" is displayed.  
Use  or  to choose "Yes" or "No".
- Tap  (Enter).

### Note

- The printer is unable to print this information if "Roll Length" is set to "Off".

 ["Roll Length Manage4: Roll Length" P. 129](#)



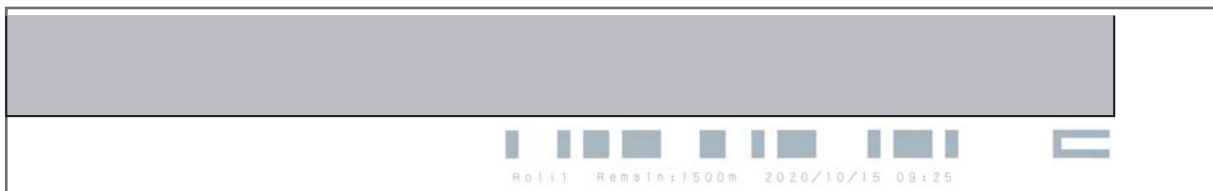

- This menu will print the following information:
  - Type of roll media
  - Remaining roll length
  - Date printed
  - Remaining length management code



## Roll Length Manage2: Simple Print

Print the remaining length management information with text only on the roll media.

Roll Length Manage2  
Simple Print

- Tap .
- "Do you want to cut?" is displayed.  
Use  or  to choose "Yes" or "No".
- Tap  (Enter).

### Note

- The printer is unable to print this information if "Roll Length" is set to "Off".

 ["Roll Length Manage4: Roll Length" P. 129](#)

- This menu will print the following information:
  - Type of roll media
  - Remaining roll length
  - Date printed

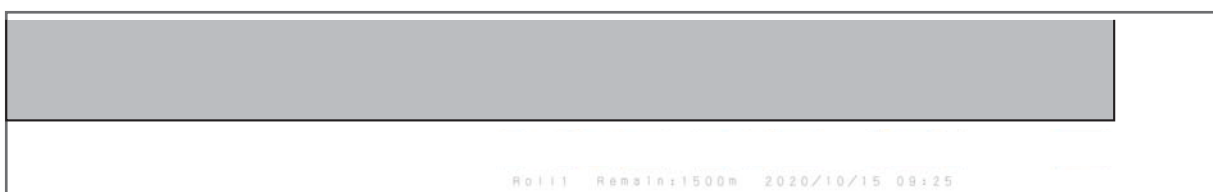

## Roll Length Manage3: Scan

Your printer can scan the remaining length management code that was printed on a roll media with "[Roll Length Manage1: Print](#)".

- [1] Load a roll media that the remaining length management code has been printed on it.

 "[Load a roll media into the printer](#)" P. 25

 "[Roll Length Manage1: Print](#)" P. 127

- [2] Check that the code printed on the media has passed through the pressure rollers.

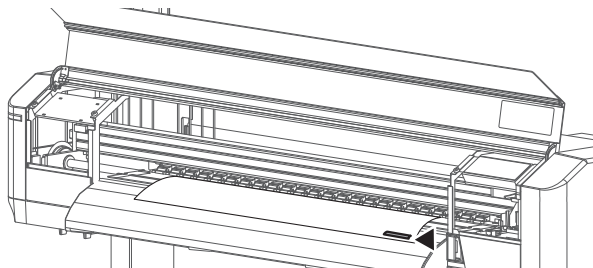

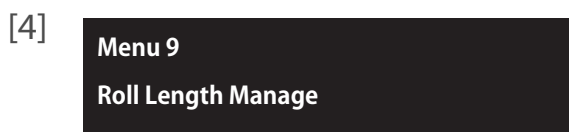

Tap  (Home).

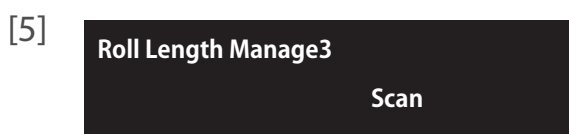

Tap  until the menu on the left appears.

• Tap .



Tap  until the menu on the left appears.

• Tap  (Enter).

• Tapping the  (Cancel) key while scanning will cancel the scan.

- [6] When your printer scanned successfully, the following settings will be specified in Roll Length automatically:

- Type of roll media
- Remaining roll length

 "[Roll Length Manage4: Roll Length](#)" P. 129

### Note

- The printer may fail to scan if a remaining length management code has dirt or fold marks on it.
- Your printer is unable to scan if "Output Mode" is set to "Take Up".  
 "[Setup 6: Output Mode](#)" P. 91
- In case the printer failed to scan the code, manually specify the Roll Length settings based on the remaining length management information printed in text on the media.

 "[Roll Length Manage4: Roll Length](#)" P. 129

## Roll Length Manage4: Roll Length

Roll Length Manage4  
Roll Length

Sets up the media length.

### Setting values

Roll Kind: Off

Roll Length is not used.  
This is the initially set value.

Roll Kind: Roll \*

Sets up the media length.  
The set values of the media length can be set as "Roll1" to "Roll3".

### When the "Roll Kind" is set to "Roll 1", "Roll 2" or "Roll 3"

#### Length menu

Roll Kind: Roll 1

Sets up the media length.

### Setting values

Length: (1 - 1500) 30 m

1 m to <30 m> to 1,500 m  
<> indicates the initial value.

#### Print stop menu

Length: (1 - 1500) 30 m

Sets whether or not to display "Roll Remain Error" and pause printing when the length of the media that is counted inside the printer becomes 0.

### Setting values

Print Stop: Off

The media remaining count is not used to judge for pausing printing. Printing pauses when the rear sensor responds.  
This is the initially set value.

Print Stop: On

Even when the rear sensor does not respond, printing pauses when the media remaining count becomes 0.

#### Note

- Normally you can set this as "Off" as the rear sensor detects when the roll paper is finished.
- If you are using the media that does not come off the paper core easily when it is finished, printing may not be paused when the media is finished, if the "Print stop menu" is set to "Off". If this happens, set this to "On".

## Near End menu



Sets whether or not to display "Roll Near End: \*m" (\* is replaced with a number between 1 and 10) before the length of the media that is counted inside the printer becomes 0.

### Setting values



"Near end" is not displayed. This is the initially set value.



"Near end" is displayed when the remaining count for the media becomes the length you selected.

## Roll Length Manage5: Auto Scan

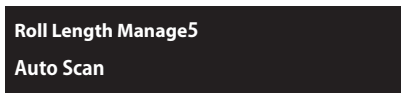

The ON setting will automatically scan the remaining length management code printed on a roll media when

- the printer is powered on.
- you replace a roll media.

Tapping the  (Cancel) key while scanning will cancel the scan.

When your printer scanned successfully, the following settings will be specified in Roll Length automatically:

- Type of roll media
- Remaining roll length

 ["Roll Length Manage4: Roll Length" P. 129](#)

### Setting values





Automatic scan of remaining length management code is disabled. The default is set to Off.



Automatically scans the remaining length management code printed on a roll media when

- the printer is powered on.
- you replace a roll media on the printer.

### Note

- The printer may fail to scan if a remaining length management code has dirt or fold marks on it.
- In case your printer is unable to read the code even if this setting is ON, check that the following settings are set to "OFF" or "Auto cut".  
 ["Setup 4: Media Initial" P. 90](#), ["Setup 6: Output Mode" P. 91](#)
- In case the printer failed to scan the code, manually specify the Roll Length settings based on the remaining length management information printed in text on the media.  
 ["Roll Length Manage4: Roll Length" P. 129](#)

## Roll Length Manage6: Auto Print

### Roll Length Manage6 Auto Print

The ON setting will prompt the confirmation message when you perform media cutting, asking you whether to print a remaining length management information on a roll media. This option helps you to shorten the steps to print a remaining length management code.

#### Setting values

Auto Print:



Off

This confirmation message will not be displayed when you perform media cutting. The default is set to Off.

Auto Print:

On

The confirmation message "Print Roll's Remain?" appears when you perform media cutting.

Use  or  to choose "Yes" or "No".

and then Tap  (Enter).

- When "Yes" is selected  
The printer prints a remaining length management code on a roll media after media is cut.
- When "No" is selected  
This code will not be printed on a roll media after media is cut.

#### Note

- The Auto Print function cannot be enabled if "Roll Length Manage4: Roll Length" is set to OFF.

 ["Roll Length Manage4: Roll Length" P. 129](#)

# Menu 10 : Media Adjustment

Menu 10  
Media Adjustment

Automatically performs print quality calibration and media feed adjustment.

## Setting values

User Type:  
Type 1

Select a user type.

You can select from Type 1 to Type 15.



Use  or  to enter the value, and tap



(Enter), to enter the setting and move on to the media thickness setting.

Set the thickness of the media to be used.  
80  $\mu\text{m}$  to <170  $\mu\text{m}$ > to 1,300  $\mu\text{m}$

Type \*\*: 8  
Thickness

Use  or  to enter the value, and tap





(Enter), to begin automatic adjustment.

### Note

- The initially set values for user type and media thickness reflect the values for the currently selected user type.
- The user type and media thickness selected here are reflected in the set values.



## Procedure for media adjustment

1. Set "User Type" and then tap the  (Enter).
2. Set "Thickness" and then tap the  (Enter).
  - The adjustment pattern is printed.
  - The color sensor reads the print result and performs automatic adjustment.
3. When adjustment is completed, "AutoAdjust Succeeded OK -> Enter" is displayed.
  - If adjustment failed, "AutoAdjust Failed OK -> Enter" is displayed.
4. Tap  (Enter) to end the adjustment.

- If adjustment failed, re-try media adjustment or use the standard or custom adjustment printing to perform adjustment.

 ["Print quality calibration" P. 41](#)

 Note

- If failed in the middle of the calibration, the adjustment value for the pattern which has been successfully calibrated will be saved in the printer, but the adjustment value for the pattern which has been failed to calibrate or has not been calibrated yet will not be saved in the printer.
- Warm up the heater before printing the Confirm and Adjustment patterns.  
"Skip Heater Warm Up? No" is displayed on the front panel.
- You can start printing while the printer is warming up.  
 ["Starting printing during warming up" P. 56](#)
- If image quality does not improve even after performing adjustment (if there is banding or a grainy look), re-try media adjustment or use the standard or custom adjustment printing to perform adjustment.  
 ["Print quality calibration" P. 41](#)
- If a roll media starts to cockle during calibration, load the media again.

 **CAUTION**



**While "Warming Up" is displayed, do not touch Media guide.**  
You could burn yourself.

# Menu 11 : CR Maintenance

Menu 11  
CR Maintenance

Performs maintenance. Used in the following cases.

- Cleaning and replacing of cleaning wiper
- Cleaning of print head circumference
- Cleaning the color sensor
- Cleaning around the capping unit
- Replacing cutter

 ["Maintenance" P. 140](#)

---

## Submenus

---

CR Maintenance

Start

-> Enter

Performs maintenance.

CR Maintenance

End

-> Enter

Completes maintenance.

Perform the pumping operation (start/  
stop) by using .

# Menu chart

## Setting menu 1

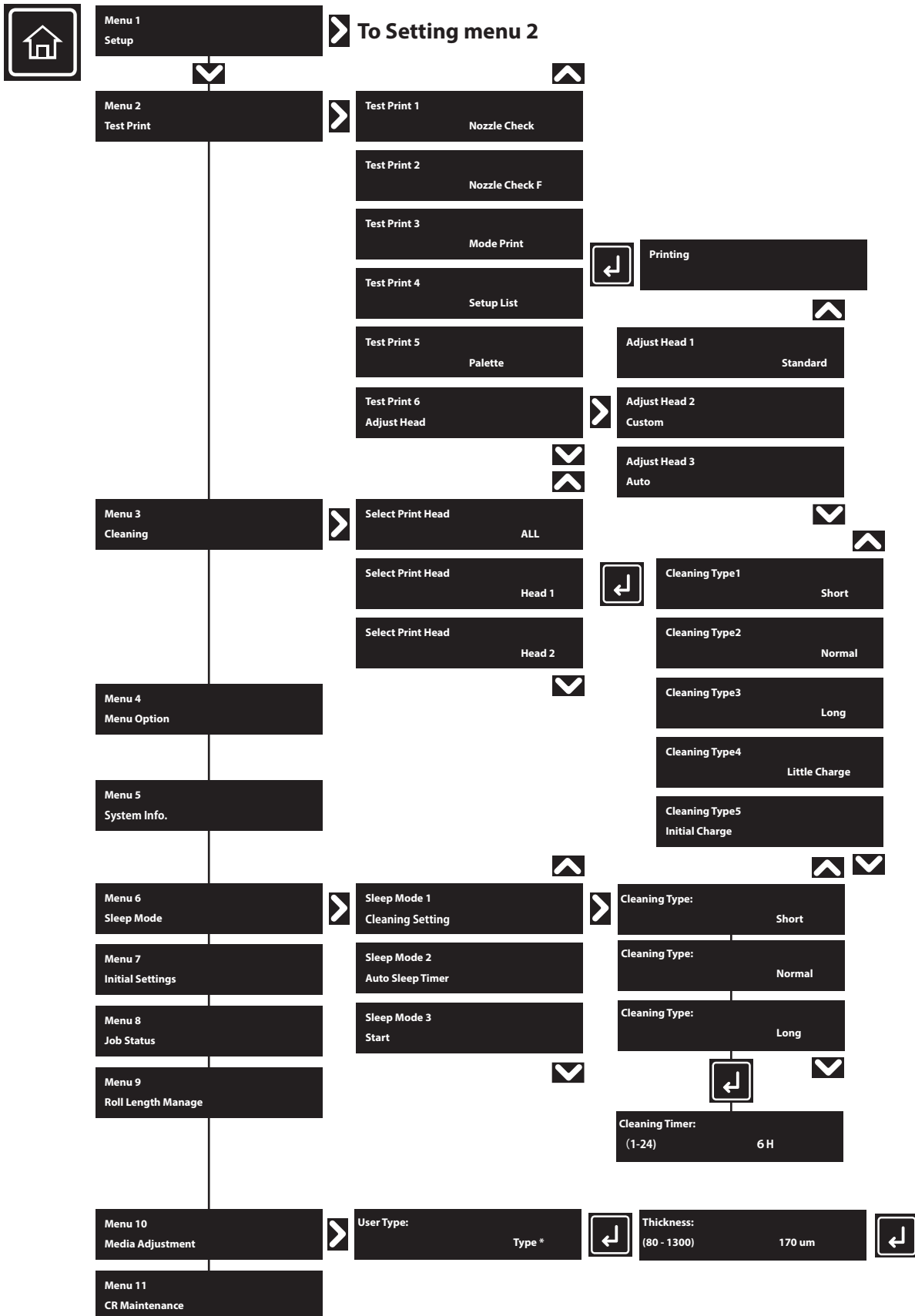

# Setting menu 2

## From Setting menu 1

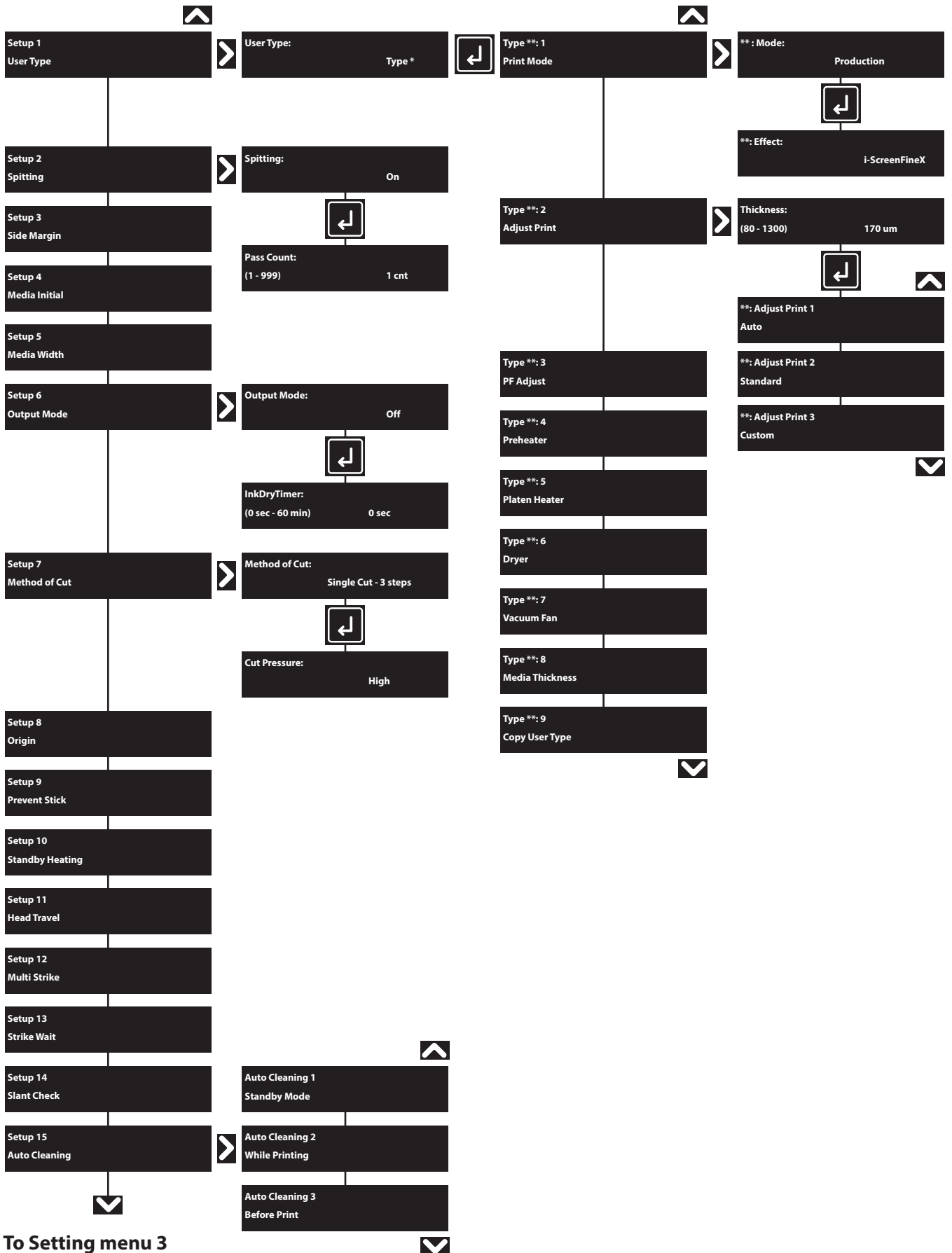

## Setting menu 3

### From Setting menu 2

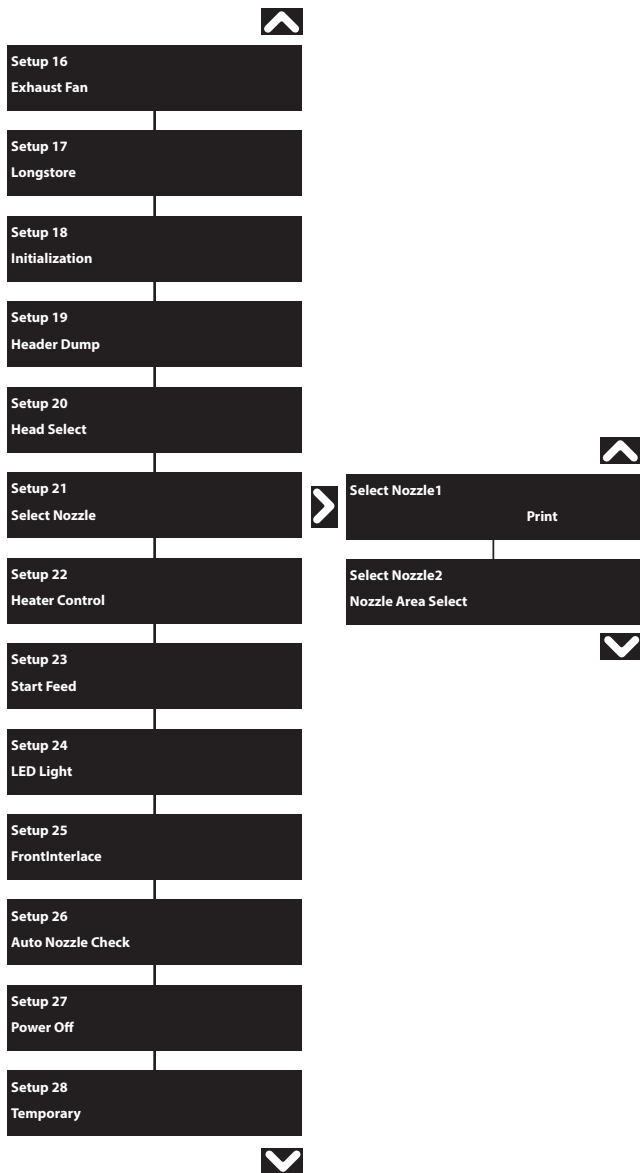

# Menu during printing

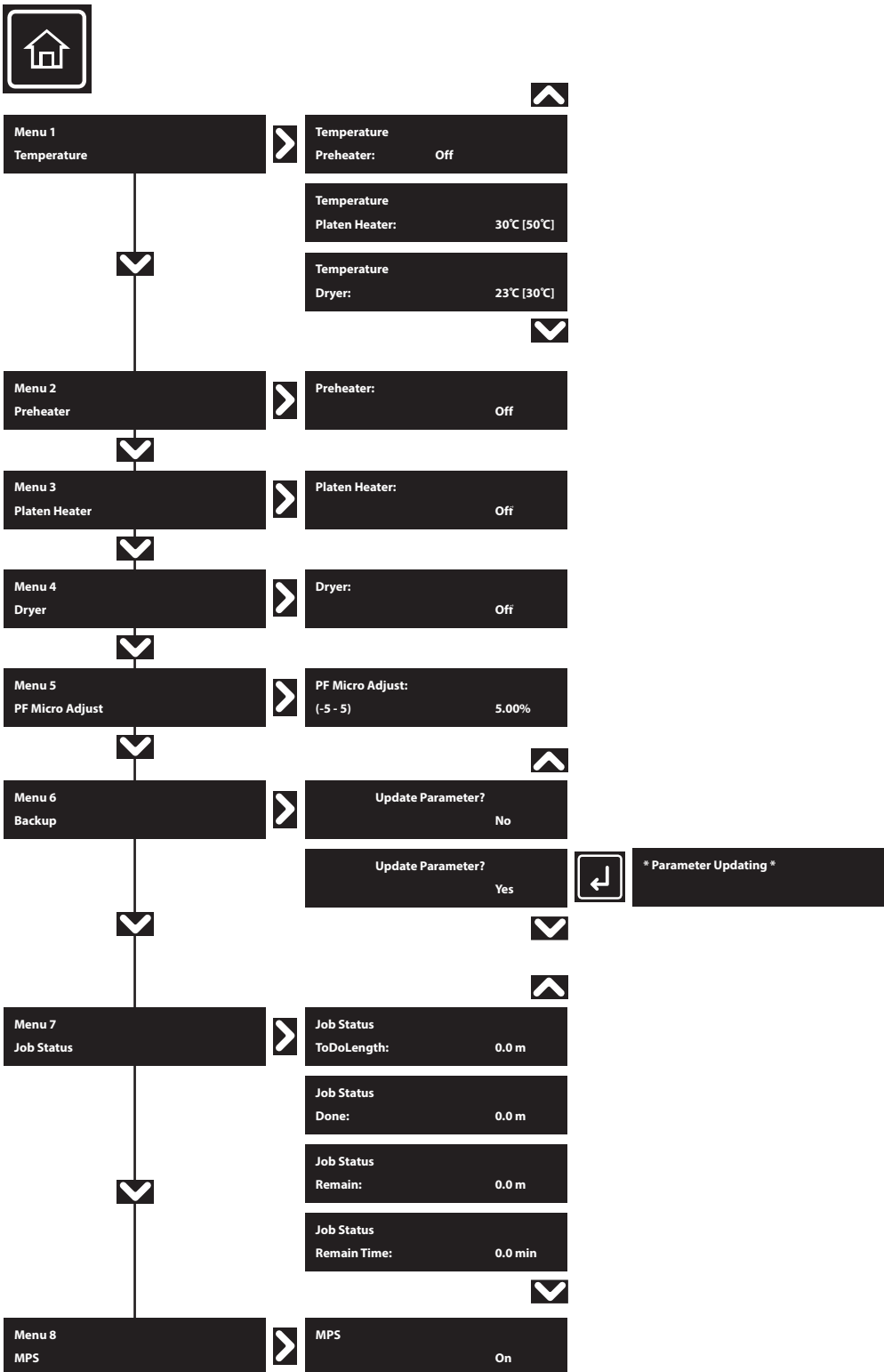

# Chapter 3 Maintenance

|   |     |
|---|-----|
| Maintenance.....  | 140 |
| Checking ink and replacing ink bag.....                 | 141 |
| Checking ink level.....                                 | 141 |
| When it becomes time to replace ink bag.....            | 142 |
| Replacing ink bag.....                                  | 142 |
| Emptying waste ink tank.....                            | 145 |
| Emptying waste ink tank.....                            | 145 |
| Cleaning.....   | 147 |
| Head cleaning.....                                      | 147 |
| Soak Cleaning.....                                      | 149 |
| Cleaning of cleaning wiper.....                         | 150 |
| Cleaning around the capping unit.....                   | 153 |
| Cleaning around the print head.....                     | 155 |
| Cleaning the color sensor.....                          | 157 |
| Inside cleaning.....                                    | 159 |
| Replacing consumable parts.....                         | 160 |
| Replacing absorption material for the flushing box..... | 160 |
| Replacing Cutter.....                                   | 162 |
| Replacing the cleaning wiper.....                       | 164 |
| Moving or transporting the printer.....                 | 167 |
| Moving the printer.....                                 | 167 |
| Transporting the printer.....                           | 168 |
| Long-term storage.....                                  | 169 |
| Performing initial charging after head cleaning.....    | 174 |

# Maintenance

To maintain the performance of this product, please conduct maintenance by yourself.  
The types of maintenance are shown next.

|                                  |   |
|----------------------------------|---|
| Before and after daily operation | <a href="#">"Nozzle check and cleaning" P. 35</a>                           |
| Based on your usage condition    | <a href="#">"Head cleaning" P. 147</a>                                      |
|                                  | <a href="#">"Cleaning of cleaning wiper" P. 150</a>                         |
|                                  | <a href="#">"Cleaning around the print head" P. 155</a>                     |
|                                  | <a href="#">"Cleaning the color sensor" P. 157</a>                          |
|                                  | <a href="#">"Replacing ink bag" P. 142</a>                                  |
|                                  | <a href="#">"Emptying waste ink tank" P. 145</a>                            |
|                                  | <a href="#">"Replacing absorption material for the flushing box" P. 160</a> |
|                                  | <a href="#">"Replacing Cutter" P. 162</a>                                   |
| Weekly                           | <a href="#">"Cleaning of cleaning wiper" P. 150</a>                         |
|                                  | <a href="#">"Cleaning around the capping unit" P. 153</a>                   |
| Monthly                          | <a href="#">"Inside cleaning" P. 159</a>                                    |
| Every twelve months              | <a href="#">"Replacing the cleaning wiper" P. 164</a>                       |
| When not used for a week or more | <a href="#">"Head cleaning" P. 147</a> (Once a week)                        |
| When not used for a long period  | <a href="#">"Long-term storage" P. 169</a>                                  |

## Important!

Since a service technician has to handle following cases, please contact your local MUTOH dealer.

- Error requiring restart is happening repeatedly.
- The message to notify the life of print head, pump and various motors is displayed.

 ["Messages and Error Messages" P. 178](#)

# Checking ink and replacing ink bag

## Checking ink level

[1]

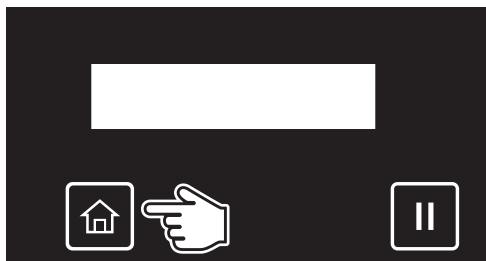

Tap  (Home).

[2]



Tap  until the menu on the left appears.

• Tap .

[3]



Tap  until the menu on the left appears.

• Tap  (Enter)

[4]

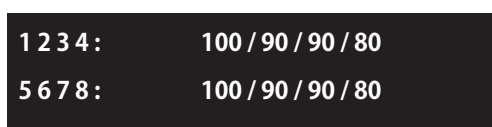

The ink level is displayed from 0% to 100%.



Note

• To identify the ink slots corresponding to each ink color shown here, see ["Main components of your printer" P. 9](#).

### • 4-color setting

|   |              |   |              |   |             |   |             |
|---|--------------|---|--------------|---|-------------|---|-------------|
| 1 | K1 (Black)   | 2 | K2 (Black)   | 3 | C1 (Cyan)   | 4 | C2 (Cyan)   |
| 5 | M1 (Magenta) | 6 | M2 (Magenta) | 7 | Y1 (Yellow) | 8 | Y2 (Yellow) |

### • 8-color setting

|   |                    |   |                 |   |                  |   |             |
|---|--------------------|---|-----------------|---|------------------|---|-------------|
| 1 | M (Magenta)        | 2 | C (Cyan)        | 3 | K (Black)        | 4 | Or (Orange) |
| 5 | Lm (Light Magenta) | 6 | Lc (Light Cyan) | 7 | Lk (Light Black) | 8 | Y (Yellow)  |



Note

• If it is blinking at 10%, smartchip recovery is being performed on the corresponding S/C card.

 ["Smartchip recovery" P. 183](#)

## When it becomes time to replace ink bag

When the ink level becomes low, the error LED of the front panel flashes and a buzzer sounds.

[1]

[1] S / C Ink Low

PG: Low1

W: 1625 m

Tap  (Enter).

- The buzzer stops. If the ink is not replaced after a while, the buzzer will sound again.
- In the figure to the left, the slot 1 ink bag is nearing replacement.

[2] Prepare the replacement ink bag.

## Replacing ink bag

When an ink bag runs out of ink, the error message [Ink End] or [S/C Ink End] appears on the panel with blinking error LED and beep sound. Replace with a new ink bag and a new S/C card immediately. The printer will not resume printing until the ink bag is replaced.

### CAUTION



**Wear the protective gloves · glasses · mask and avoid contact with your eyes or skin.**

Eye or skin contact may cause slight irritation or bloodshot eyes. If in eyes or on skin, immediately flush with water. If irritation is present, seek medical advice/attention immediately.

### Important!

- **Do not replace ink bag when the printer is powered off.**  
**Ink level cannot be detected correctly.**
- **If ink bag is moved from cold to warm place, leave it in the room temperature at least three hours.**
- **If you do not have any replacement ink bag, do not remove the empty ink bag from the printer.**  
**This may cause the nozzle clogs.**

## 1. Removing the ink bag case

- [1]  Tap  (Enter).
- The buzzer stops.
  - In the figure to the left, the slot 1 ink bag must be replaced.

- [2] Remove the ink bag case and S/C card that you need to replace from each slot.

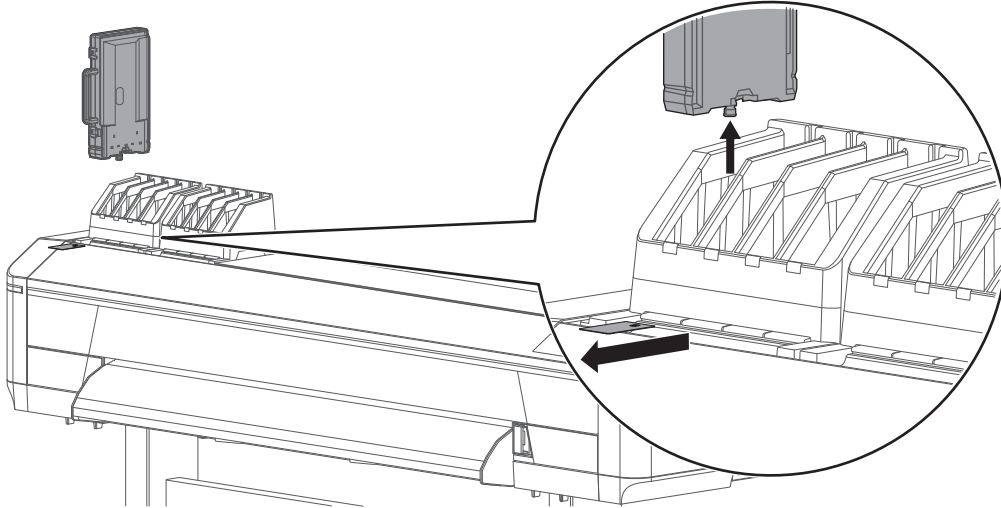

- [3]  Unlock four latches and open the ink bag case.

 **Important!**

**Try not to apply excessive force to unlock them. This will cause damage to the latch.**

- [4]  Remove the empty ink bag.

 **Note**

Place the used ink bag in a plastic bag or the like and dispose of the ink bag according to the local regulations.

## 2. Installing the ink bag

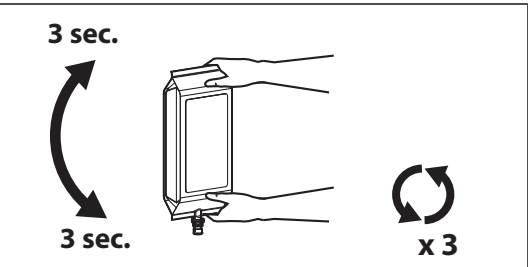
- [1]  Prepare the new ink bag, and follow the instructions below to invert it to mix the ink.
- Face the ink spout side upwards for 3 seconds.
  - Invert it and count for 3 seconds.
  - Repeat that 3 times.

[2]

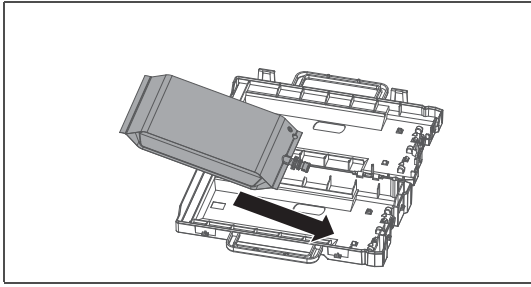

Put the ink bag into the case.

Gusset-type pack

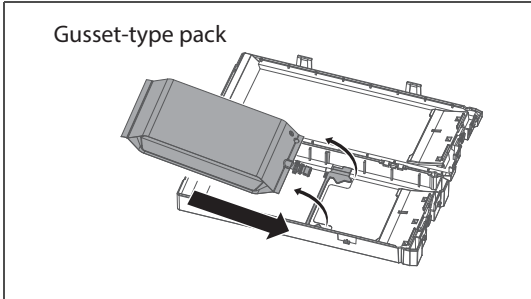

**Important!**

**If using 1 L packs with the ink pack case (1,000 ml / 2,200 ml)**

- If using a gusset-type pack, lock the divider plate.
- If using a flat-type pack, unlock the divider plate.

Gusset-type pack

Flat-type pack

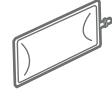
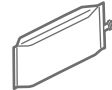

[3]

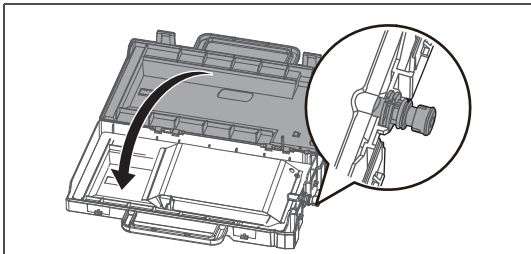

Close the ink bag case.

**Important!**

**Make sure the spout of ink bag is properly fitted into the groove in the case.**

**If not fitted, the printer cannot correctly detect ink bag.**

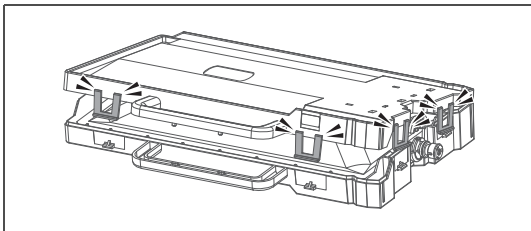

Close all the latches (x4) of the case properly.

**Important!**

**Check that all the latches (x4) are closed.**

**If not, it may cause ink spillage.**

[4]

Insert the ink bag case with the new ink bag installed and new S/C card into each slot.

- Match the colors of the ink color indicating label on the printer and the label on the ink bag.
- Face the latch side toward you and insert the case into each slot.
- Make sure that they are fully inserted.

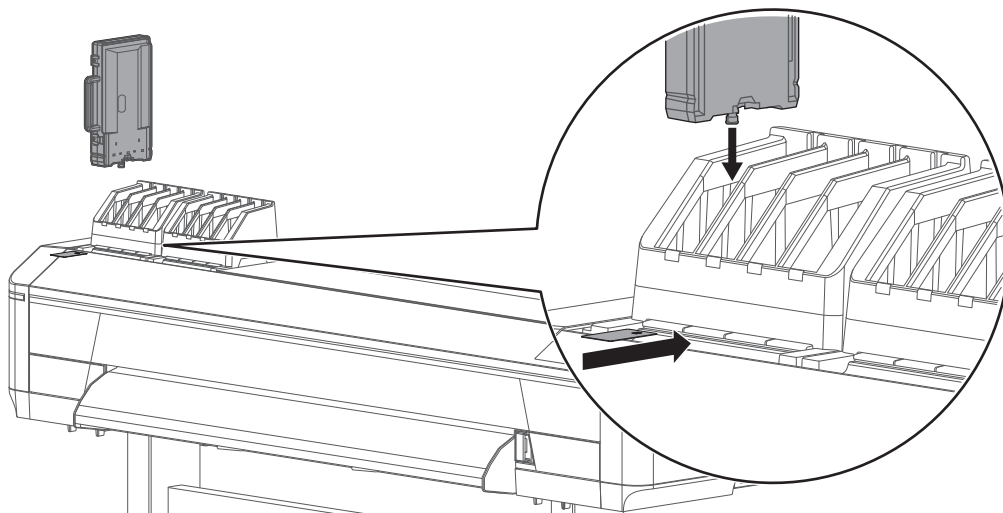

# Emptying waste ink tank

## Emptying waste ink tank

In the following cases, drain waste ink in the waste ink tank into a container to empty the tank.

- When the waste ink tank is more than half full.
- When "Full WasteInkTank" is displayed on the front panel.

### Display messages



Full Waste Ink Tank

The waste ink tank is full. Empty the tank immediately.

- The printer will stop operation until you empty the waste ink tank. If the waste ink is not drained after a while, the buzzer will sound again.

#### Important!

**Empty the waste ink tank before moving the printer.**

## 1. Drain waste ink into a container

### WARNING



**Waste ink collected from this product is classified as industrial waste. Dispose of waste ink according to the local waste disposal regulations.**

### CAUTION



**Wear the protective gloves • glasses • mask and avoid contact with your eyes or skin.**

Eye or skin contact may cause slight irritation or bloodshot eyes. If in eyes or on skin, immediately flush with water. If irritation is present, seek medical advice/attention immediately.

[1] Prepare a container to collect waste ink.

#### Important!

**The capacity of the waste ink tank is 2,000 ml. Make sure to prepare a container with at least 2,000 ml capacity.**

[2] Cover the floor just under the waste ink tank using a paper that you do not use.

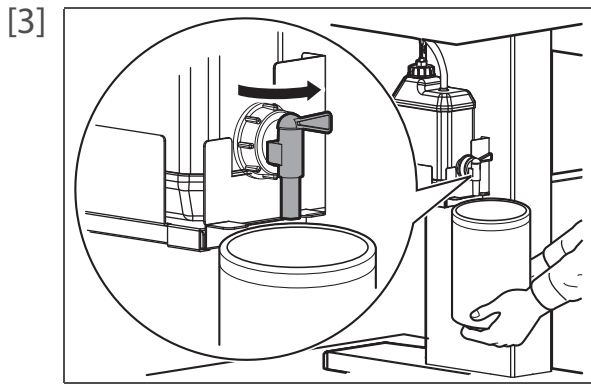

Open the waste ink valve and drain waste ink into the container.



**To avoid ink splash, move the container closer to the waste ink valve while draining waste ink.**

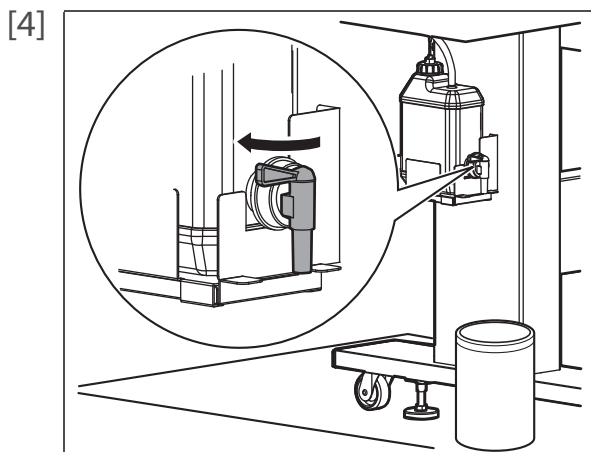

Once you empty the tank, close the waste ink valve securely.

- Wipe the opening of the valve with a cloth.

[5] Dispose of waste ink according to the local waste disposal regulations.

# Cleaning



To maintain your printer in the best condition, cleaning must be performed as instructed.

## Head cleaning

If you find missing or thin lines on your print or nozzle check print, perform head cleaning.

Following cleaning modes are available:

---

|                 |   |
|-----------------|---|
| Short cleaning  | Consumes less ink than Normal cleaning.   |
| Normal cleaning | If nozzle clogging is found on the nozzle check print, perform Normal cleaning.   |
| Long cleaning   | If nozzle clogging still persists after Normal cleaning, perform Long cleaning.<br>It consumes more ink than Normal cleaning.   |
| Little Charge   | Little Charge gives higher cleaning than Long cleaning, but consumes large amount of ink.<br>To access to this menu, go to "Menu 3 Cleaning" > "Cleaning Type".<br> <a href="#">"Menu 3: Cleaning" P. 116</a>            |
| Initial Charge  | Initial Charge offers more powerful cleaning than Little Charge, but consumes large amount of ink.<br>To access to this menu, go to "Menu 3 Cleaning" > "Cleaning Type".<br> <a href="#">"Menu 3: Cleaning" P. 116</a> |

---

### Important!

**When you perform "Little Charge" or "Initial Charge";**

- **Do not power off the printer.**
- **Do not disconnect the power cords.**
- **Do not open the front cover and maintenance cover during cleaning.**
- **Do not release the pressure rollers.**
- **Do not remove ink bag cases and S/C cards from the printer.**
- **Be sure that remaining ink in the ink bag is enough to perform cleaning.**

**If cleaning is interrupted, it may consume more amount of ink.**

## 1. Performing Head cleaning

---

[1]

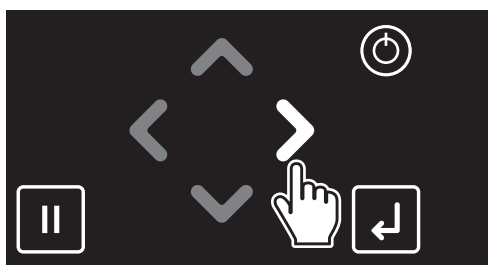

Tap .

[2]

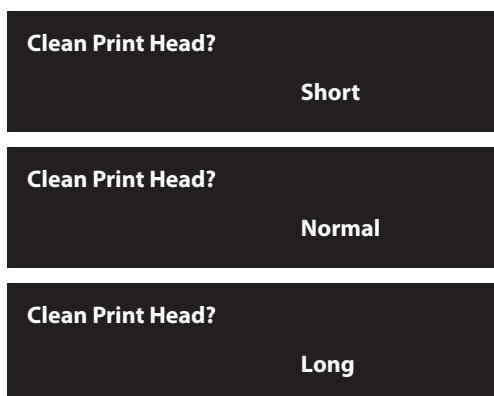

Use  or  to choose the cleaning mode.

Tap  (Enter).

- The printer will start cleaning.

[3] Run a nozzle check.

## 2. Performing Nozzle check

---

[1] Load a roll media to print the nozzle check pattern.

 ["Loading a roll media" P. 25](#)

[2]

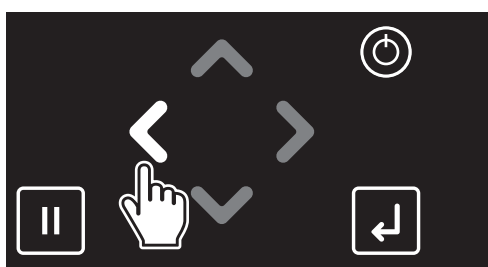

Tap .

[3]



Tap  (Enter).

- The printer will print the nozzle check pattern.

[4] Check the print result.

- If you find missing or thin lines on the print, go to **"Performing Head cleaning" P. 148.**
- If all lines are clearly printed, you can start printing.

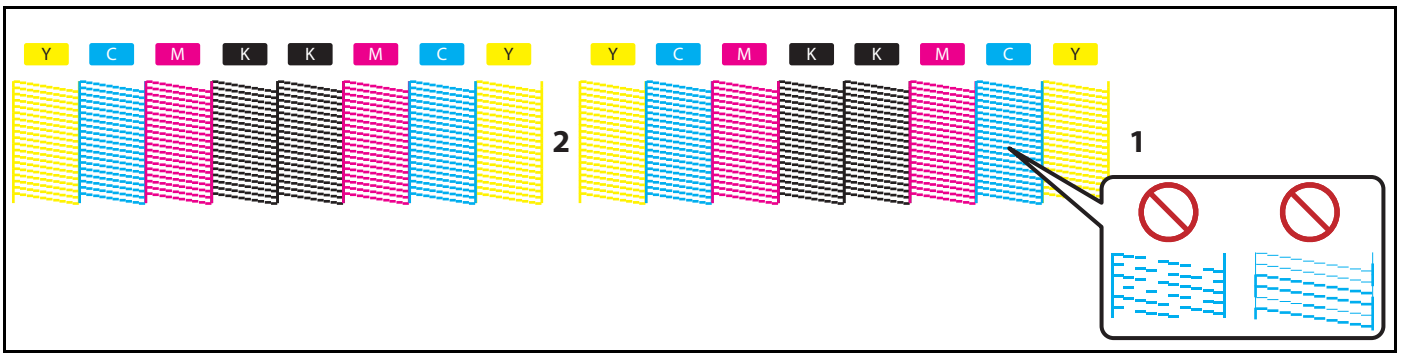

#### Note

- The pattern shown above is an example when printed with 4-color configuration.
- If nozzle clogging persists after repeating normal cleaning several times, perform Long cleaning.
- If several Long cleaning does not help to recover nozzles, perform **"Cleaning of cleaning wiper" P. 150** or **"Cleaning around the print head" P. 155.**
- If nozzle clogging still persists, perform Little Charge from "Menu 3 Cleaning" > "Cleaning Type".  **"Menu3: Cleaning" P. 116**
- If "Long" or "Little Charge" cleaning does not help to recover the nozzles, go to **"Setup 21: Select Nozzle" P. 101** to select the nozzles that fire properly.

## Soak Cleaning

### Cleaning period:

- Weekly (recommended)
- Nozzle clogging or nozzle deflection persists after cleaning attempt.

For procedures, download the soak cleaning procedure sheet from MUTOH Club ( <https://mutoh-club.com/mutoh/guser/> ).

# Cleaning of cleaning wiper

## Cleaning period:

- Weekly
- When print blurring and dot missing remain after head cleaning is done.

## Preparation:

- Cleaning stick

### Important!

During cleaning, please note the followings.

- If it is hard to remove the stain, perform "Short" Head cleaning, and then clean again.
- Use a dry cleaning stick. A damp stick can cause damage to the print head.
- Do not touch the tip of a cleaning stick with fingers. Skin oil will damage the print head.
- Do not reuse a cleaning stick. Dust on the stick will damage the print head.
- This cleaning takes about 5 minutes. If it takes longer, the stick will get dry causing damage to the print head.

## 1. Putting the printer into the CR maintenance mode

[1]

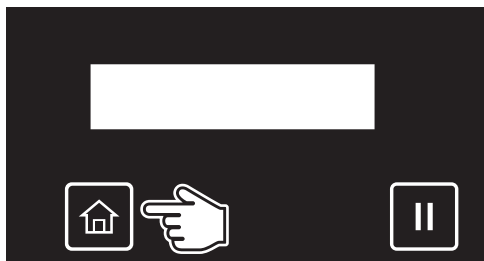

Tap  (Home).

[2]



Tap  until the menu on the left appears.

- Tap .

[3]

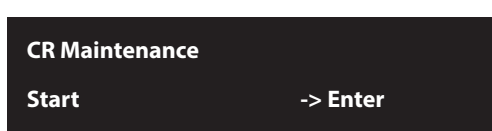

Tap  (Enter).

- The carriage will move to the left side of the printer.
- The cleaning wiper will move upward.

[4]

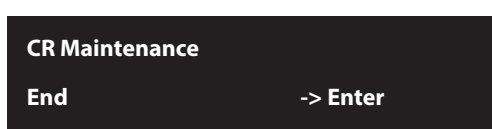

The message on the left will appear.

- You can start cleaning process.

### Note

- If you tap the  key while "CR Maintenance End -> Enter" is displayed, the pump is activated, sucking up the ink in the cap.

### Note

The standard cleaning time of each part is about 5 minutes. When over 10 minutes has passed since the printer has put into CR maintenance mode, and the covers have been opened, the message "Close cover" will appear on the panel with beep sound. Please close all the covers and tap the Enter key to exit CR maintenance mode once. To resume the maintenance, please start from step 3.

## 2. Cleaning the cleaning wiper

[1]

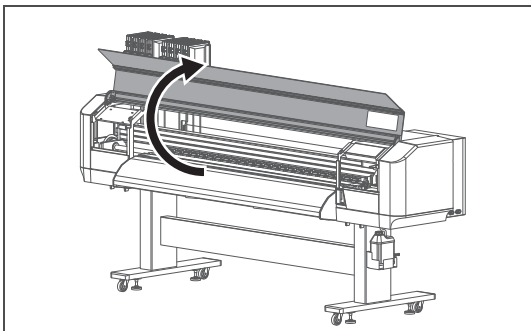

Open the front cover.

[2]

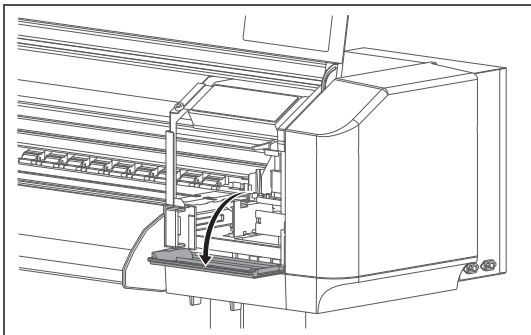

Open the maintenance cover on the right side.

[3]

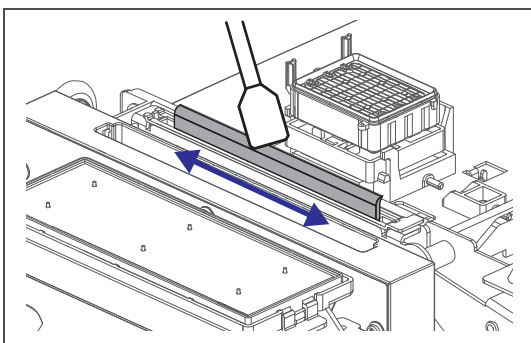

Wipe the cleaning wiper with a cleaning stick.

- Wipe the left side of the wiper back and forth.

 **Important!**

**If it is hard to remove the stain, perform "Short" Head cleaning, and then clean again.**

[4]

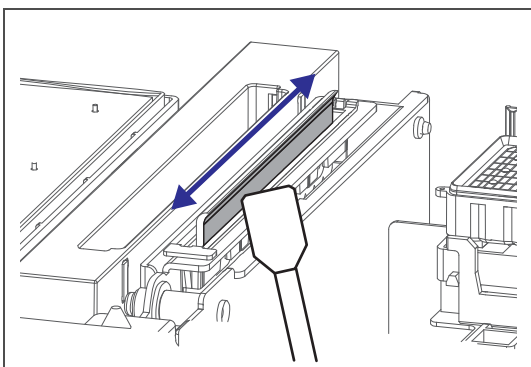

Wipe the right side of the wiper back and forth.

[5]

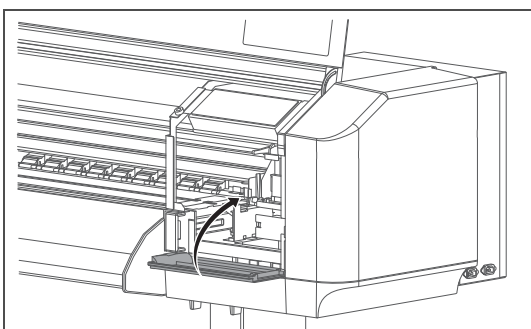

Close the maintenance cover.

[6]

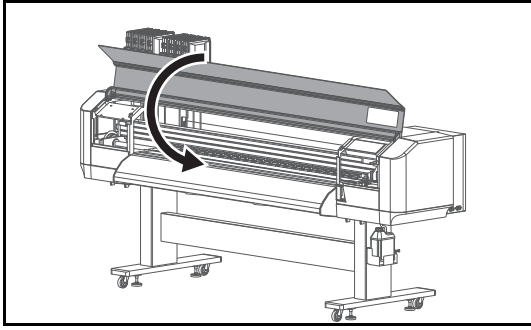

Close the front cover.

[7]

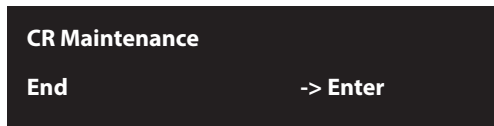

Tap  (Enter).

[8]

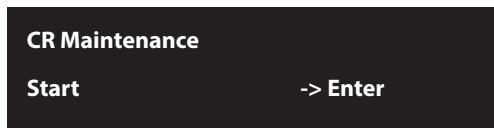

Tap  (Home) to end the cleaning process.

 Note

Used cleaning stick should be put in a plastic bag, etc, and dispose of it in compliance with local ordinance and instructions of local authorities.

## Cleaning around the capping unit

### Cleaning period:

- Weekly

### Preparation:

- Cleaning stick

#### Important!

During cleaning, please note the followings.

- Use a dry cleaning stick. A damp stick can cause damage to the print head.
- Do not touch the tip of a cleaning stick with fingers. Skin oil will damage the print head.
- Do not reuse a cleaning stick. Dust on the stick will damage the print head.
- This cleaning takes about 5 minutes. If it takes longer, the stick will get dry causing damage to the print head.

[1] Put the printer into the CR maintenance mode.

 ["Putting the printer into the CR maintenance mode" P. 150](#)

[2] Open the front cover.

[3]  Open the maintenance cover on the right side.

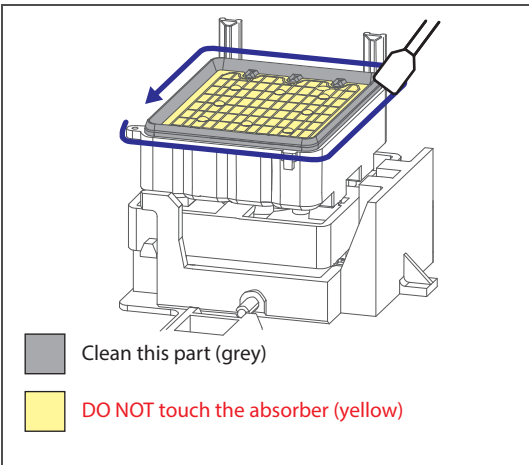
[4]  Use the cleaning stick to clean around the rubber part of the capping unit to remove the ink deposits and dust.  
(Capping unit: 2)

#### Important!

**If it is hard to remove the stain, perform "Short" Head cleaning, and then clean again.**

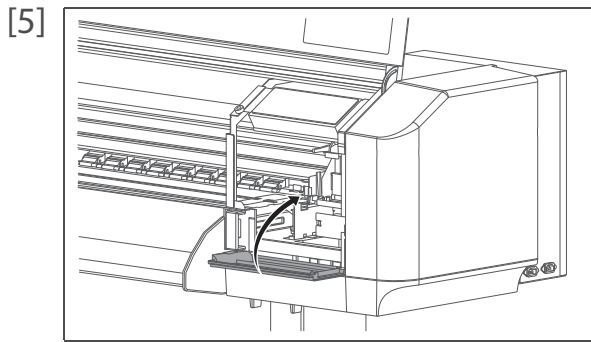

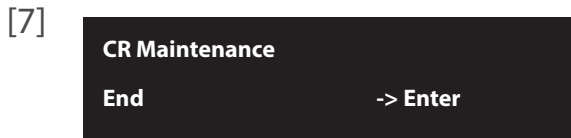

Close the maintenance cover.

[6] Close the front cover.

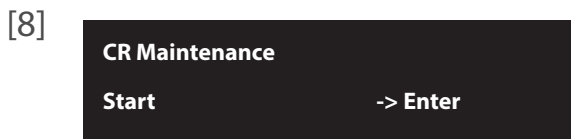

Tap  (Enter).



Tap  (Home) to end the cleaning process.

 Note

Used cleaning stick should be put in a plastic bag, etc, and dispose of it in compliance with local ordinance and instructions of local authorities.

## Cleaning around the print head

### Cleaning period:

- When print blurring and dot missing remain after head cleaning is done.
- When smears partially appears on the prints.

### Preparation:

- Cleaning stick



**During cleaning, please note the followings.**

- **Use a dry cleaning stick. A damp stick can cause damage to the print head.**
- **Do not touch the tip of a cleaning stick with fingers. Skin oil will damage the print head.**
- **Do not reuse a cleaning stick. Dust on the stick will damage the print head.**
- **This cleaning takes about 5 minutes. If it takes longer, the stick will get dry causing damage to the print head.**

[1] Put the printer into the CR maintenance mode.

 ["Putting the printer into the CR maintenance mode" P. 150](#)

[2] Open the front cover.

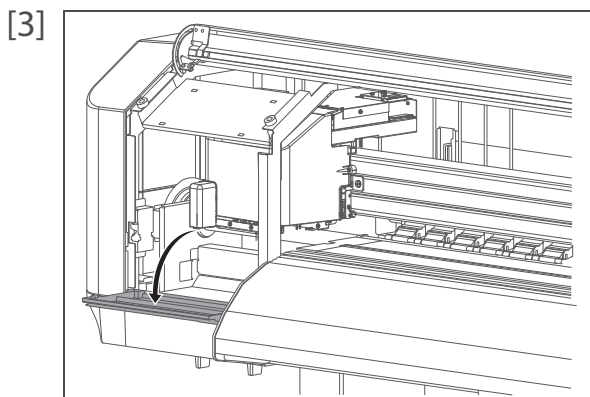

Open the maintenance cover on the left side.

[4] Use the cleaning stick to remove the ink deposits or dust on the bottom of the carriage.

 Clean this part (grey)

 **DO NOT touch the surface of a print head (yellow)**

- Surface around print head ※Clean the space between the print head and print head guide.  
Clean the left and right sides of the print head as well.
- Print head guide (black plastic part) ※Clean the space between the print head guide and bottom of the carriage.  
Clean the space between two print head guides.

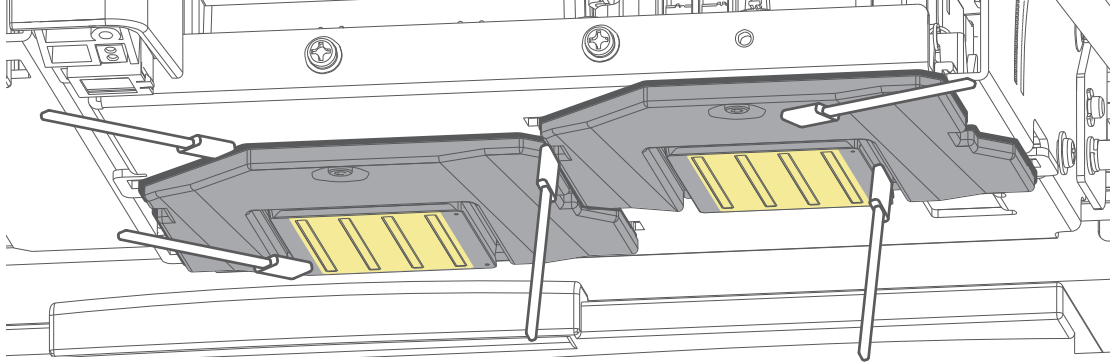

 **Important!**

**If it is hard to remove the stain, perform "Short" Head cleaning, and then clean again.**

[5]

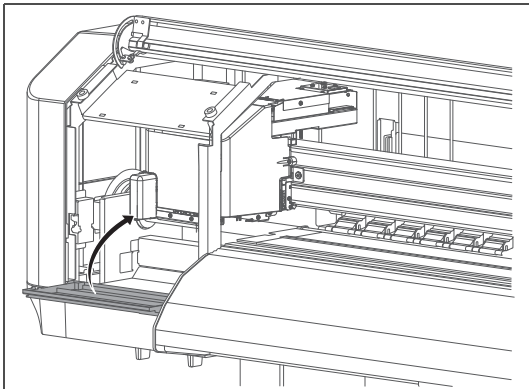

Close the maintenance cover.

[6]

Close the front cover.

[7]

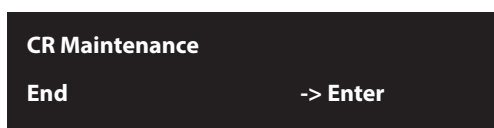

Tap  (Enter).

[8]

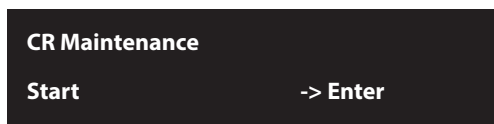

Tap  (Home) to end the cleaning process.

 **Note**

Used cleaning stick should be put in a plastic bag, etc, and dispose of it in compliance with local ordinance and instructions of local authorities.

## Cleaning the color sensor

### Cleaning period:

- If you repeatedly failed to perform an auto head alignment ("Adjust Head 3: Auto") or auto print quality calibration ("Adjust Print 1: Auto").

### Preparation:

- Cleaning stick
- Ethanol (commercially available item: Use one with a concentration of 50% or higher.)

#### Important!

During cleaning, please note the followings.

- Do not push the glass on the color sensor too hard with a cleaning stick. This will damage the glass.
- Do not reuse a cleaning stick. Dust may adhere to the color sensor causing malfunction.
- This cleaning takes about 5 minutes. If it takes longer, the stick will get dry causing damage to the print head.

[1] Put the printer into the CR maintenance mode.

 ["Putting the printer into the CR maintenance mode" P. 150](#)

[2] Open the front cover.

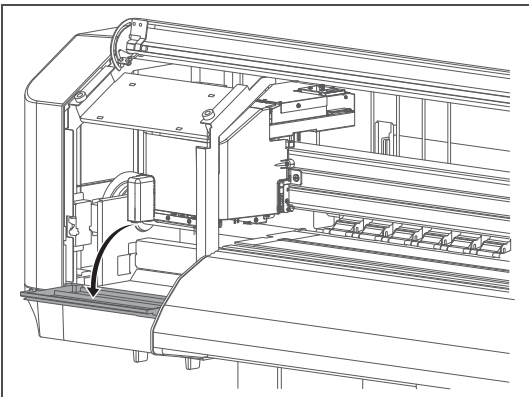
[3]  Open the maintenance cover on the left side.

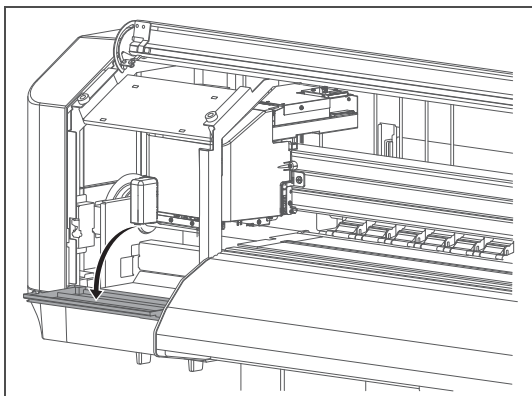

[4] Using a cleaning stick slightly dampened with ethanol, gently clean the glass on the color sensor located at the bottom of the carriage to remove ink and dust.

 Clean this part (Do not push the glass too hard.)

 DO NOT touch the surface of a print head (yellow)

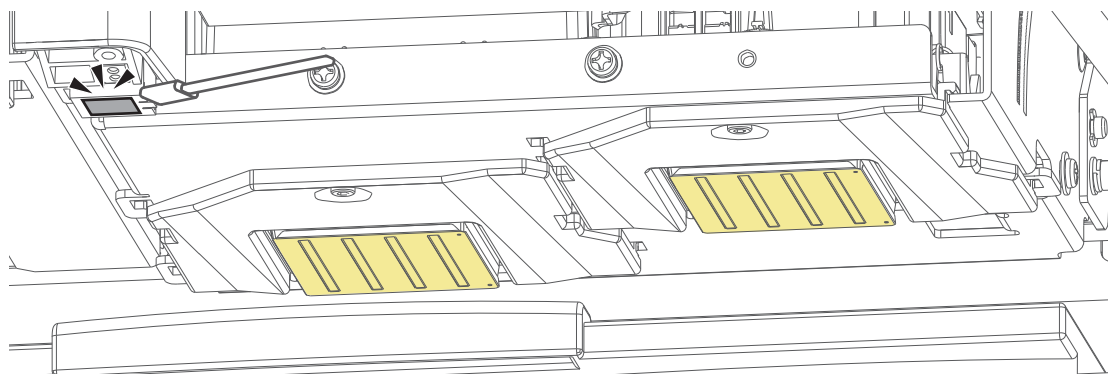

[5]

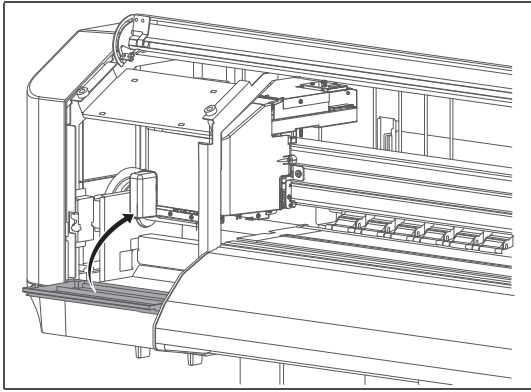

Close the maintenance cover.

[6]

Close the front cover.

[7]

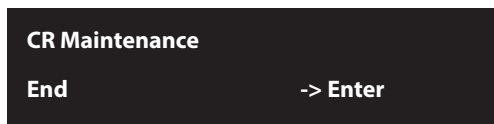

Tap  (Enter).

[8]

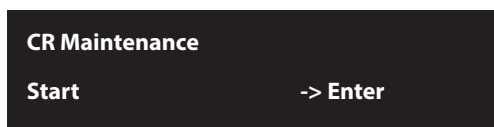

Tap  (Home) to end the cleaning process.

 Important!

**If the problem still persists, contact your local MUTOH dealer or MUTOH customer support.**

 Note

Used cleaning stick should be put in a plastic bag, etc, and dispose of it in compliance with local ordinance and instructions of local authorities.

## Inside cleaning

### Cleaning period:

- Monthly
- When dust or ink stains are visible

### Preparation:

- Soft brush
- Paper towel or Soft cloth
- Ethanol (commercially available item: Use one with a concentration of 50% or higher.)
- Gloves

### CAUTION



**Unplug the power cable with the power OFF, before cleaning the inside of the printer.**

### Steps

---

- [1] Remove the media.
- [2] Make sure that the printer is turned OFF.
- [3] Open the front cover.

### Important!

**Immediately after turning off the power, the temperature of the heater in this product is very high. Touch the platen or media guide and if it is too hot, allow it to cool before cleaning.**

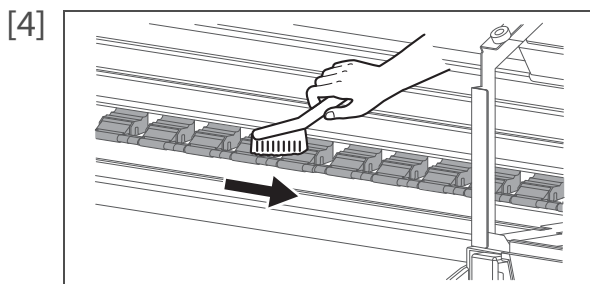

Brush off dusts on the pressure rollers with a soft brush.

### Important!

**Do not blow off dusts inside the product with a gas duster. Dust can attach to moving parts, causing abnormal sound or malfunctions.**

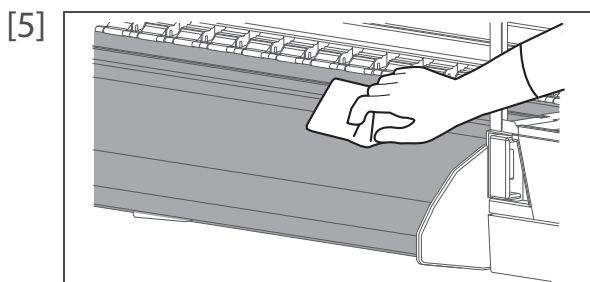

Use a soft cloth or paper towel slightly dampened with ethanol to clean off the ink on the platen, media guide and edge holders.

### Important!

**Wear protective gloves while cleaning.**

- [6] Close the front cover.

# Replacing consumable parts

## Replacing absorption material for the flushing box

The flushing box is a part that keeps receiving ink discharged from the print head. Please replace the absorption material for the flushing box periodically. If used without replacing, it can cause damage to the print head.

### Replacing period:

- When there are lumps of ink rise from the frame of the flushing box (Approx. every two months).  
\*Since it differs depending on usage frequency, please check periodically.

### Preparation:

- Absorption material for the flushing box
- Paper you can get dirty (paper which ink will not bleed through)

## 1. Checking steps

[1] Open the front cover.

[2]

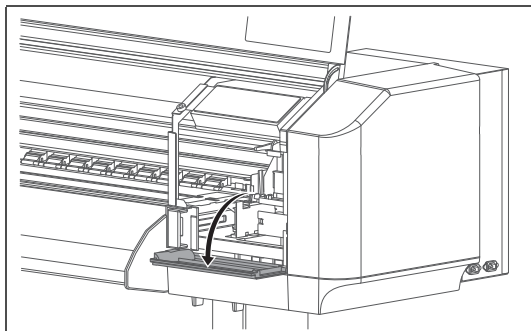

Open the maintenance cover on the right side.

[3]

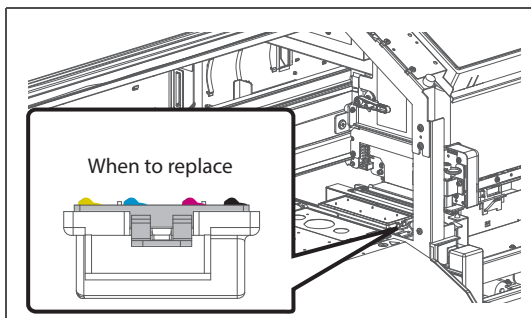

Check the absorption material for the flushing box.

- When there are lumps of ink rise from the frame of the flushing box, it is time to replace.

[4]

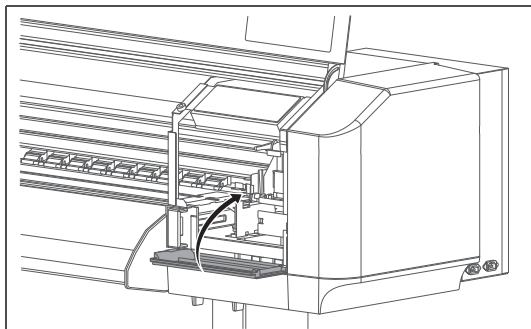

Close the maintenance cover.

[5] Close the front cover.

## 2. Replacing steps

[1] Open the front cover.

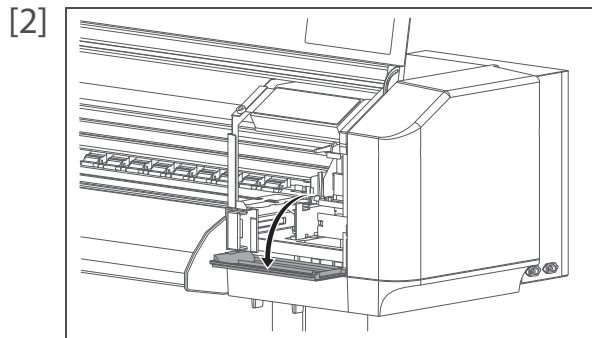

Open the maintenance cover on the right side.

[3] Cover the platen with the paper you can get dirty.

### Important!

**Ink may drip from the absorption material for the flushing box.  
We recommend covering the floor with paper as well.**

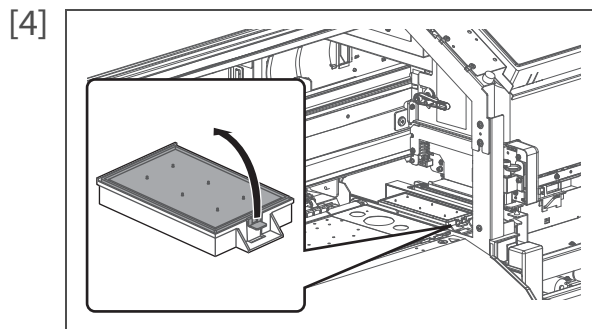

Pull the tab up of the absorption material for the flushing box, and release the hook.

Then remove the absorption material for the flushing box.

### Important!

**When removing the absorption material for the flushing box, be cautious of ink drops.**

### Note

Used absorption material for the flushing box should be put in a plastic bag, etc, and dispose of it in compliance with local ordinance and instructions of local authorities.

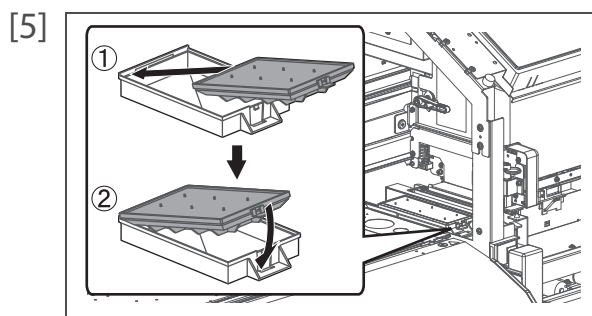

Attach new absorption material for the flushing box.

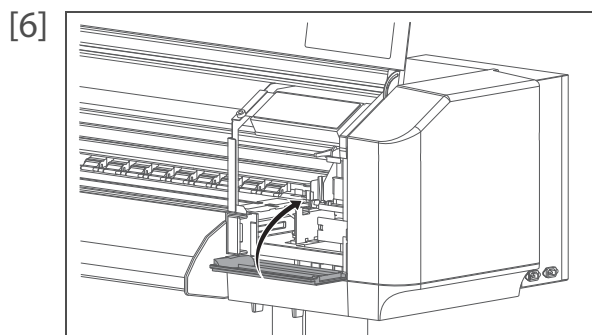

Close the maintenance cover.

[7] Close the front cover.

## Replacing Cutter

### Replacing period:

- When the media is not cut smoothly
- When the cut surface is feathered, etc

### Preparation:

- Cutter replacement blade

### CAUTION



- **Do not push the knob of cutter or release suddenly.**  
Because there is a spring under the cutter, the cutter can jump out.
- **Do not touch the cutter blade.**  
It may cause injury.

### Steps

- [1] Put the printer into the CR maintenance mode.

 ["Putting the printer into the CR maintenance mode" P. 150](#)

- [2] Open the front cover.

- [3]  Open the maintenance cover on the left side.

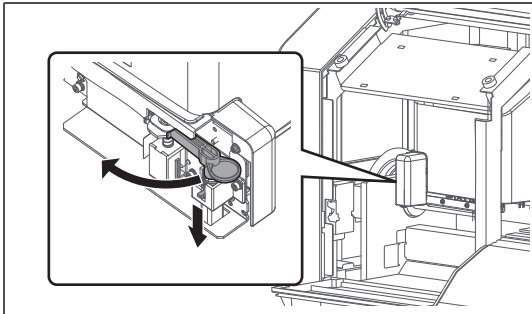
- [4]  Press the cutter cap lightly, turn Cutter holder in the direction as illustrated below.

 **Important!**

**Do not push down the cutter cap.  
It may damage the part.**

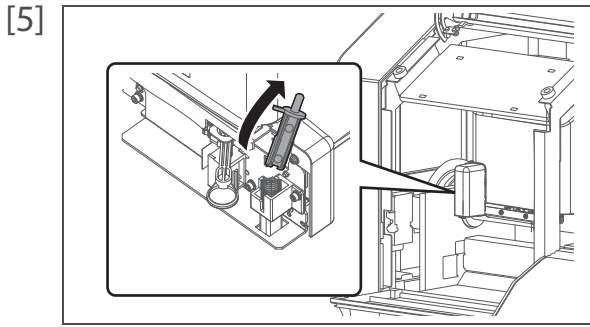

Remove the Cutter.



Note

Used Cutter should be put in a plastic bag, etc, and dispose of it in compliance with local ordinance and instructions of local authorities.

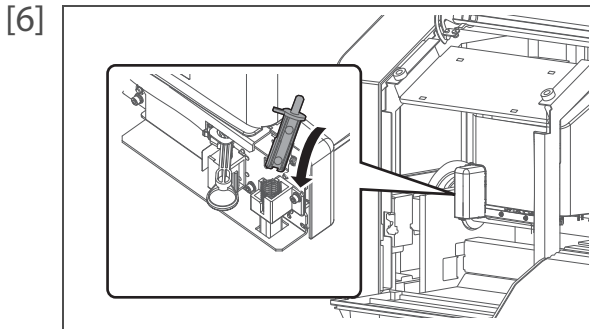

Attach a new cutter.

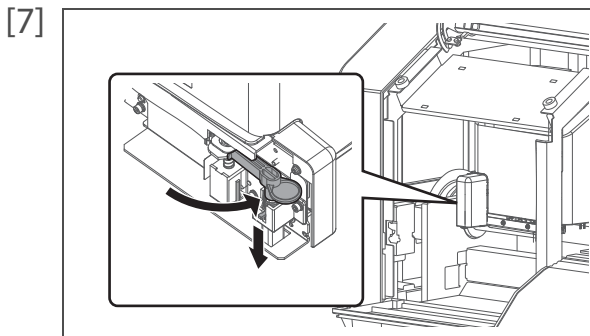

Press the cutter cap lightly, return Cutter holder to its initial position.

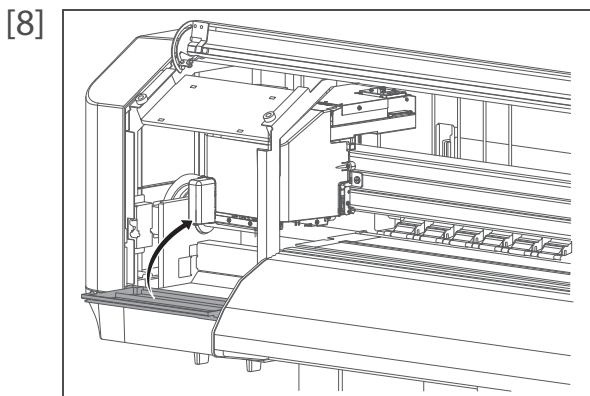

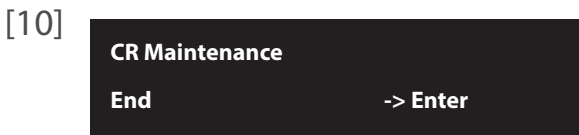

Close the maintenance cover.

[9] Close the front cover.

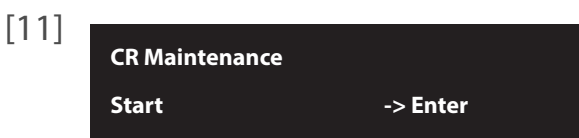

Tap  (Enter).



Tap  (Home) to end the cleaning process.

## Replacing the cleaning wiper

The cleaning wiper is an essential part to make printing consistent. Please replace it periodically.

### Replacing period:

- Approx. every twelve months

### Preparation

- Polyethylene gloves, glasses, mask
- Absorption material for the flushing box
- Paper you can get dirty (paper which ink will not bleed through)

### ⚠ CAUTION



**Wear the protective gloves · glasses · mask and avoid contact with your eyes or skin.**

Eye or skin contact may cause slight irritation or bloodshot eyes. If in eyes or on skin, immediately flush with water. If irritation is present, seek medical advice/attention immediately.

### 📢 Important!

- **Depending on the head height of the printer, two types of cleaning wipers are available; black and grey. If the head height is set to Low1, Low2 or Middle, use a black wiper (normal type). If set to High, use a grey wiper (for head height High). You will not be able to perform cleaning properly if wrong type is used on the printer.**  
👉 ["Changing the Head Height" P. 48](#)
- **This product is shipped with a black wiper attached.**

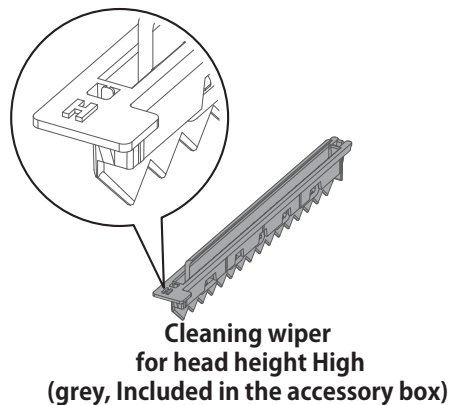
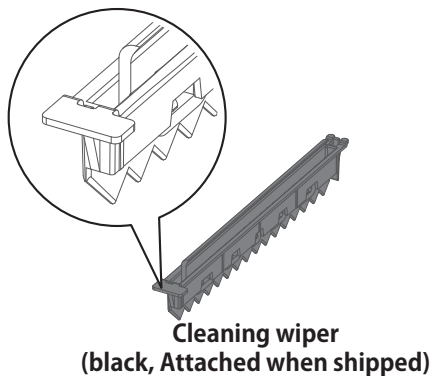

## Steps

- [1] Put the printer into the CR maintenance mode.

 **"Putting the printer into the CR maintenance mode" P. 150**

- [2] Open the front cover.

- [3]  Open the maintenance cover on the right side.

- [4] Cover the platen with the paper you can get dirty.

 **Important!**

**Ink may drip from the cleaning wiper.  
We recommend covering the floor with paper as well.**

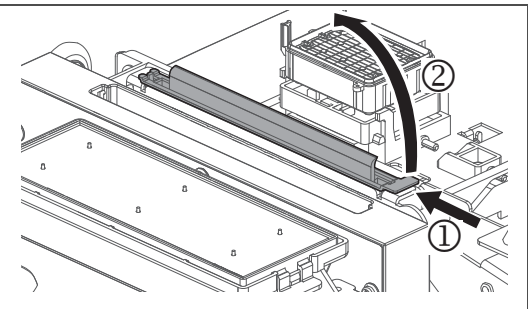
- [5]  Remove the cleaning wiper.
- Slide the hook on the wiper to the back to unhook from the wiper slot.
  - Lift the hook and remove the cleaning wiper.

 **Important!**

- **Wear protective gloves while replacing.**
- **When removing the cleaning wiper, be cautious of ink drops.**

 **Note**

Used cleaning wiper should be put in a plastic bag, etc, and dispose of it in compliance with local ordinance and instructions of local authorities.

- [6]  Follow the steps below to install new cleaning wiper.

- Slide the front side of the new cleaning wiper into its slot.
- Press the wiper hook down until it clicks into place.

 **Important!**

**Do NOT touch the cleaning wiper rubber with your bare hand.  
If finger oil gets on the rubber, it will damage the print head.**

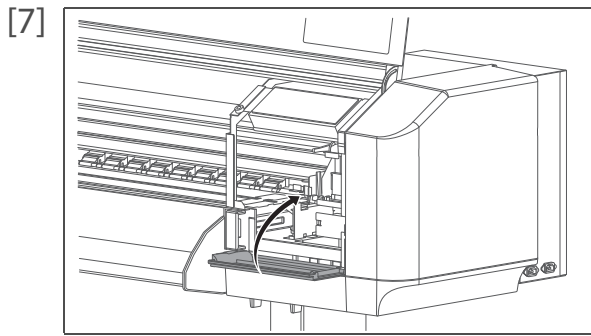

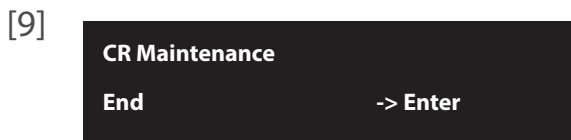

Close the maintenance cover.

[8] Close the front cover.

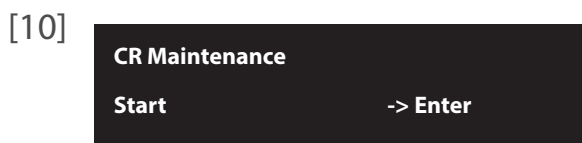

Tap  (Enter).



Tap  (Home) to end the cleaning process.

# Moving or transporting the printer

This section describes how to move or transport the printer.

## Moving the printer

This section describes how to move the printer.

### Important!

- **When moving the printer, make sure to maintain a horizontal position.**
- **Do not tilt, set against something or place this product upside down.**  
**Otherwise the ink may leak or the handling mentioned above may cause abnormality.**

### 1. Preparation before moving

---

- [1] Make sure that the printer is turned OFF.
- [2] Dispose of waste fluid.  
 ["Emptying waste ink tank" P. 145](#)
- [3] Remove all the cables, such as Power cord set.

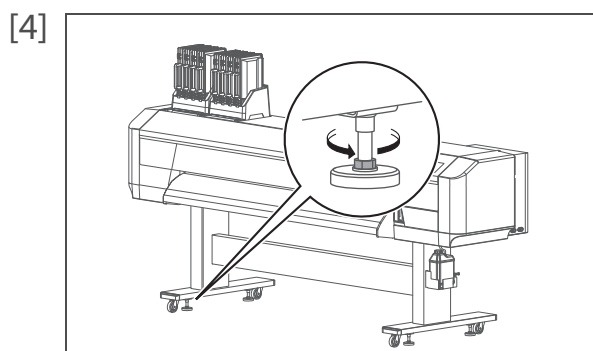



Loosen the four adjusters of Stand as shown in the left.

- [5] Move the printer.

## 2. Reinstalling

---

- [1] Select a suitable place for installation.  
 Startup Guide
- [2] Move and install the printer to the location.
- [3] Attach Cables, such as Power cord set.
- [4] Perform Nozzle check, and then confirm that there is no clogging in Print head.  
 ["Nozzle check F steps" P. 36](#)
- [5] Perform print quality adjustment.  
 ["Print quality calibration steps" P. 42](#)

### Transporting the printer

When transporting the printer, make sure to pack it in the same condition as purchased, using protective and packing materials to protect the printer from vibration and shocks.



**When transporting the printer, consult the MUTOH product dealer at your point of purchase.**

# Long-term storage

If not using the printer for a long time, execute [Longstore].

## Preparation:

- Cleaning bag: 8

[1] Empty the waste ink tank.

 ["Emptying waste ink tank" P. 145](#)



Tap  (Home).



Tap .



Tap  until the menu on the left appears.



• Tap .

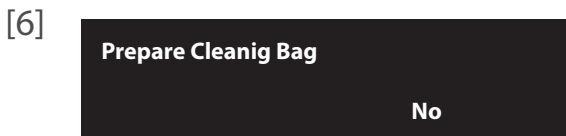

Tap  (Enter).



• Prepare the cleaning bags.

• Tap  to select "Yes" and then tap  (Enter).

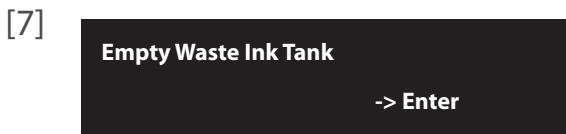
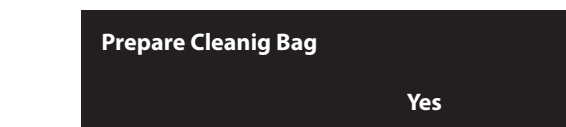

Tap  (Enter).

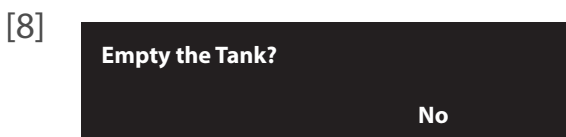

Check the waste ink tank.

• When the waste ink tank is not empty: Empty the waste ink tank.

 ["Emptying waste ink tank" P. 145](#)

• When the waste ink tank is empty: Use  to select "Yes" and then

tap  (Enter).

[9]

**Remove Bags**

The message on the left will appear.

[10]

Remove all ink bag cases and S/C cards.

- Store the ink bag together with the corresponding S/C card.

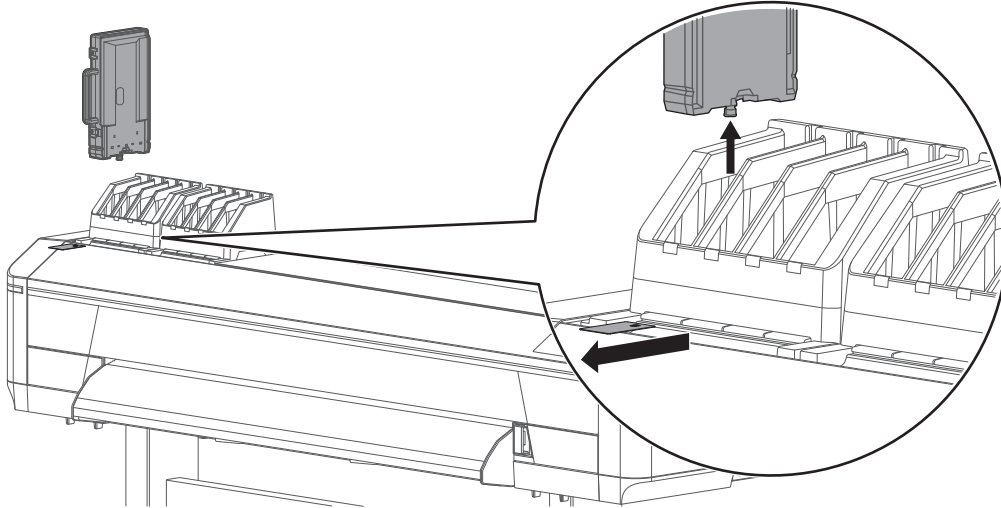

**Discharging**

The message on the left will appear.

- Ink discharging begins.

**Insert Cleaning Bags**

When the discharge is complete, the message to the left is displayed.

[11]

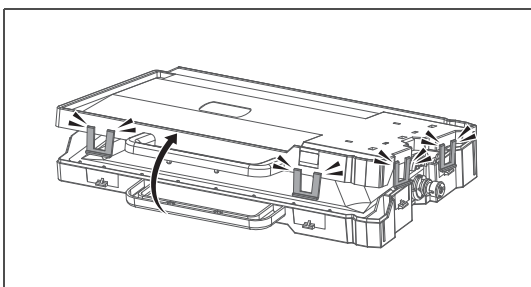

Unlock four latches and open the ink bag case.

**Important!**

**Try not to apply excessive force to unlock them. This will cause damage to the latch.**

[12]

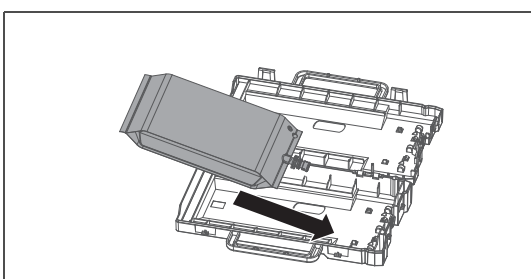

Put the cleaning bag into the case.

[13]

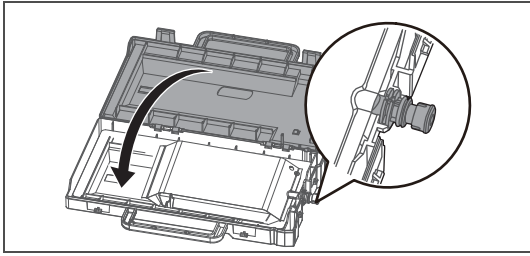

Close the ink bag case.



**Make sure the spout of cleaning bag is properly fitted into the groove in the case.  
If not fitted, the printer cannot correctly detect cleaning bag.**

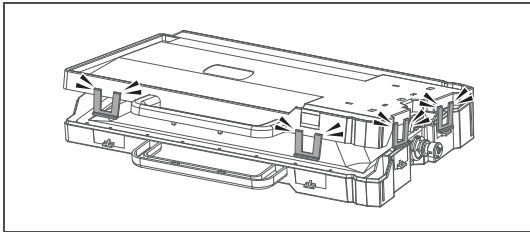

Close all the latches (x4) of the case properly.



**Check that all the latches (x4) are closed.  
If not, it may cause cleaner spillage.**

[14]

Insert the ink bag cases with cleaning bags and S/C cards into each slot.

- Face the latch side toward you and insert the case into each slot.
- Make sure that they are fully inserted.

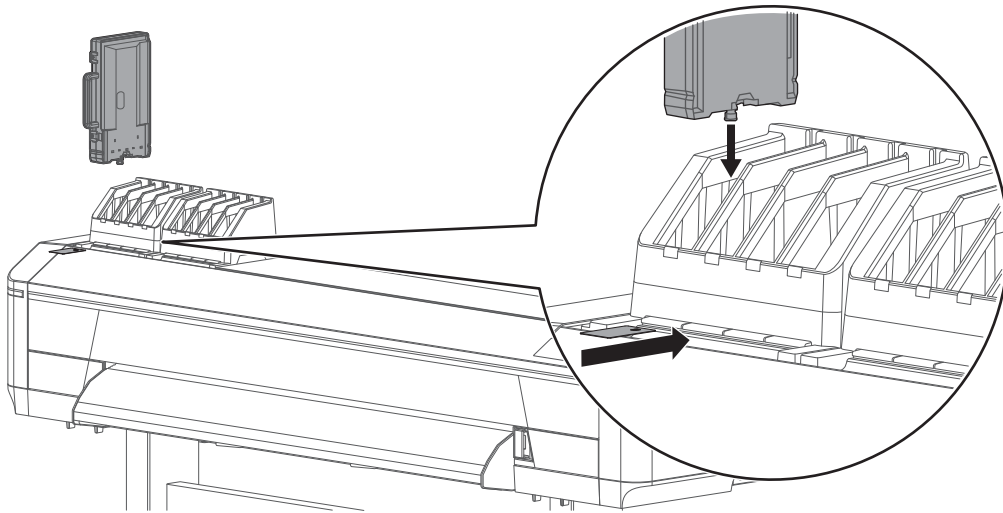

**Washing Head**

The message on the left will appear.

- Charging of the cleaner begins.

**Remove Bags**

When charging of the cleaner is complete, the message to the left is displayed.

[15] Remove all ink bag cases and S/C cards.

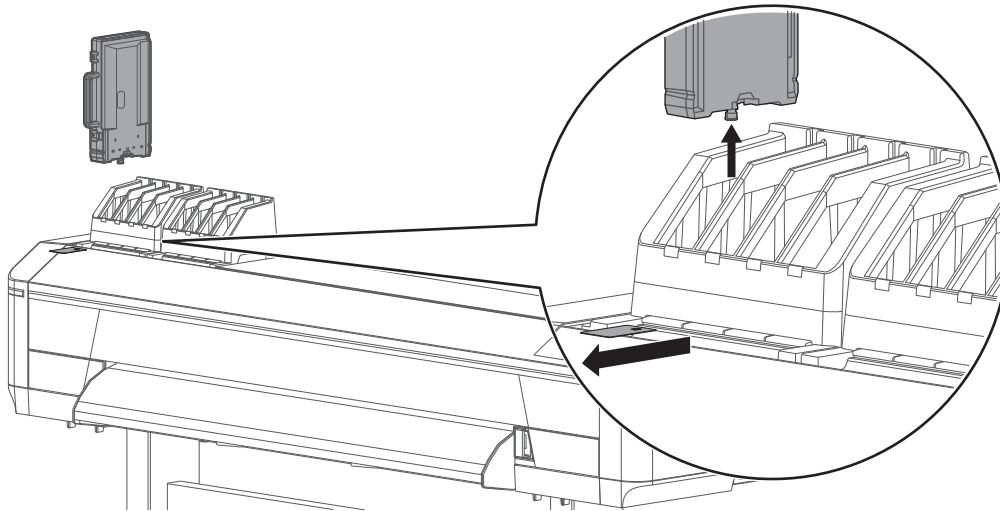

**Washing Head**

The message on the left will appear.

- Cleaner discharging begins.

**Insert Cleaning Bags**

When the discharge is complete, the message to the left is displayed.

[16] Insert the ink bag cases with cleaning bags and S/C cards into each slot.

- Face the latch side toward you and insert the case into each slot.
- Make sure that they are fully inserted.

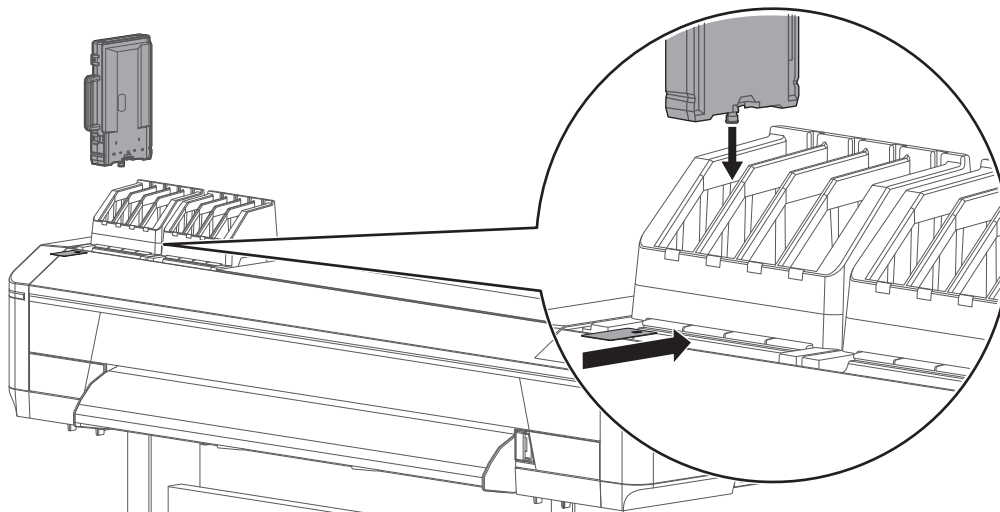

**Washing Head**

The message on the left will appear.

- Charging of the cleaner begins.

**Remove Bags**

When charging of the cleaner is complete, the message to the left is displayed.

[17] Remove all ink bag cases and S/C cards.

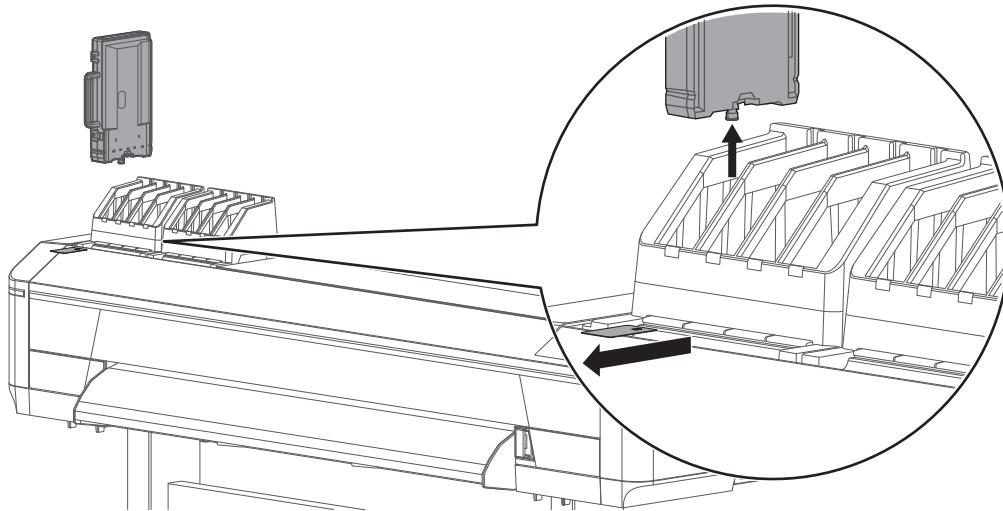

Washing Head

The message on the left will appear.

- Cleaner discharging begins.

[ALL] Discharged

When discharging is complete, the message to the left is displayed.

[18]

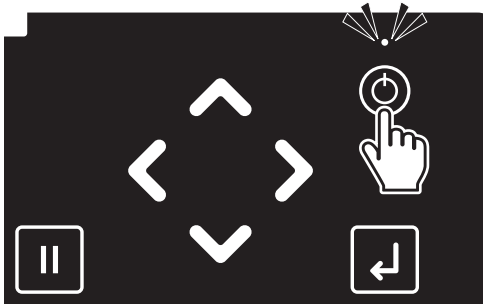

Long press the Power button.

- This product starts its powering off operations.
- When the message "Power Off" appears on the panel, release the Power button.
- The Power LED lights off.

## Performing initial charging after head cleaning

[1]

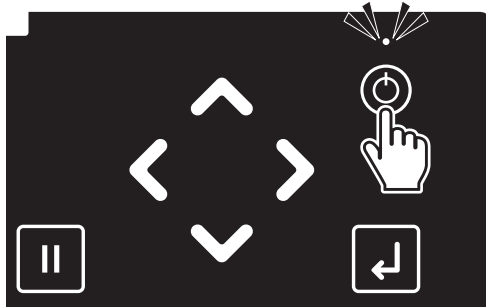

Long press the Power button.

- The Power LED (above the Power button) lights up.
- This product starts its initialization operations.

**Note**

Once the Power LED lights up, release the Power button.

[2]



When the message to the left is displayed, tap (Enter).

[3]



When the message to the left is displayed, tap (Enter).

**Note**

If you need to perform a head cleaning and "Wash retry? No" is displayed, tap the key to change the display to "Wash retry? Yes" and tap [Enter]. After that, follow the instructions displayed on the front panel.

When cleaning is complete, "Insert Ink Bags" is displayed. Proceed to step 4 in this section.

**Insert Ink Bags**

The message on the left will appear.

[4]

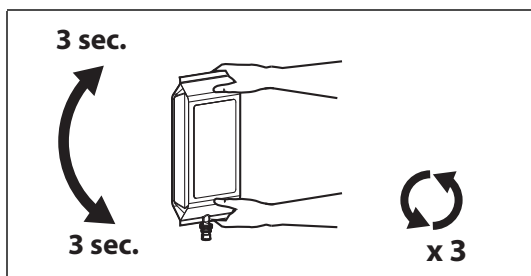

Make sure you agitate the ink bag after you prepare it.

- Face the ink spout side upwards for 3 seconds.
- Invert it and count for 3 seconds.
- Repeat that 3 times.

**Important!**

**Be sure to use new ink bags.**  
**If a half-used ink bag does not have enough ink, it will run out of ink during initial ink charging and will consume more ink.**

[5]

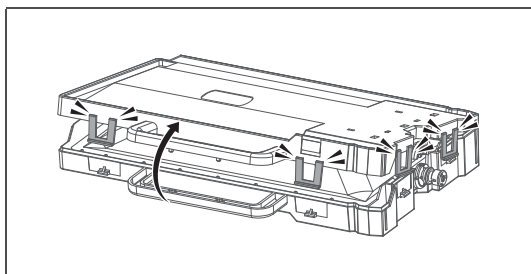

Unlock four latches and open the ink bag case.

**Important!**

**Try not to apply excessive force to unlock them. This will cause damage to the latch.**

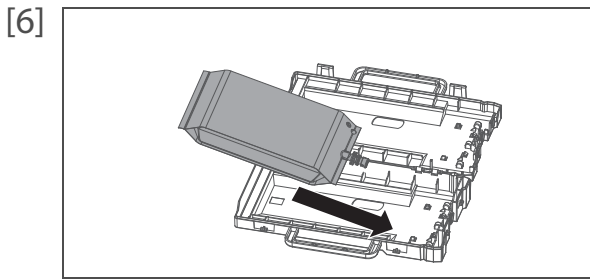

Put the ink bag into the case.

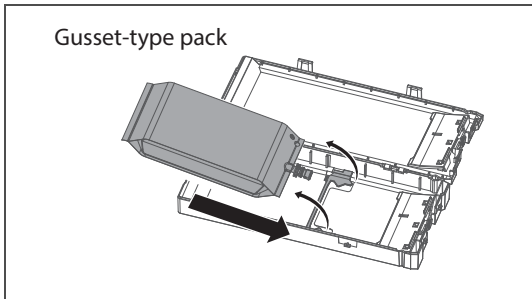

**Important!**

If using 1 L packs with the ink pack case (1,000 ml / 2,200 ml)

- If using a gusset-type pack, lock the divider plate.
- If using a flat-type pack, unlock the divider plate.

Gusset-type pack

Flat-type pack

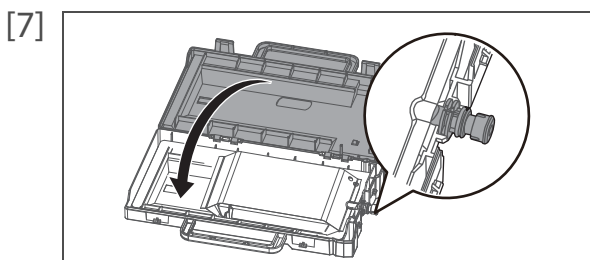
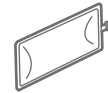
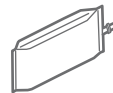

Close the ink bag case.

**Important!**

Make sure the spout of ink bag is properly fitted into the groove in the case.

If not fitted, the printer cannot correctly detect ink bag.

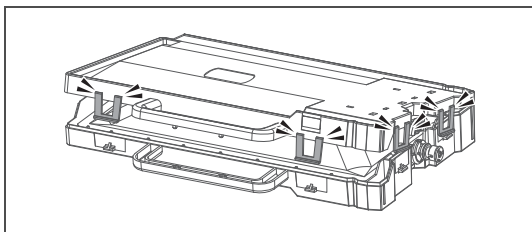

Close all the latches (x4) of the case properly.

**Important!**

Check that all the latches (x4) are closed.

If not, it may cause ink spillage.

[8] Insert the ink bag cases and S/C cards into each slot.

- Match the colors of the ink color indicating label on the printer and the label on the ink bag.
- Face the latch side toward you and insert the case into each slot.
- Make sure that they are fully inserted.

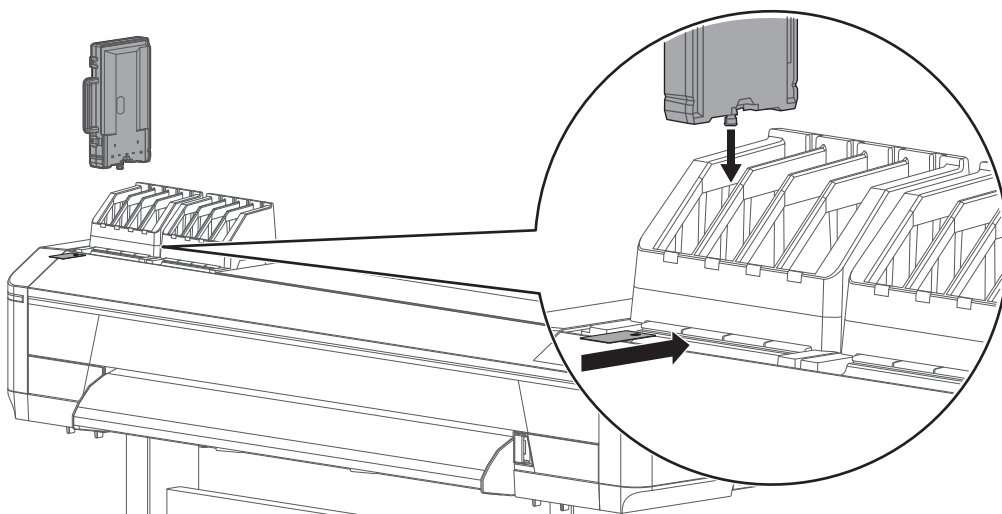

Ink Refill

\*\*%

The message on the left will appear.

- Ink charging begins.

### CAUTION



During ink charging, make sure:

- Not to turn OFF the printer.
- Not to unplug the power cable of the printer.
- Not to open the front cover.
- Not to open the maintenance cover.
- Not to release the pressure rollers.

Media End

PG: Low1

When ink charging is complete, the message to the left is displayed.

### Important!

If the printer perform the nozzle check printing immediately after the initial ink charge is complete, the following results may occur.

- Printed lines become blurred.
- The data is partially not printed.

In such cases, follow "[Menu 3: Cleaning](#)" P. 116 and perform "Little Charge". Then, check the print result.

If there is no improvement in the print result even after performing "Little Charge", leave the printer unused for an hour or more.

Then perform "Little Charge" again and check the print result.

If there is still no improvement, contact your local MUTOH dealer.

# Chapter 4 Appendix

|  |     |
|--|-----|
| Messages and Error Messages .....                    | 178 |
| Status messages .....                                | 178 |
| Error message display and remedies .....             | 180 |
| Error requiring restart .....                        | 184 |
| <br>   |     |
| Troubleshooting .....                                | 185 |
| Installation and initial setup troubleshooting ..... | 185 |
| Boot-up troubleshooting .....                        | 186 |
| Media-related troubleshooting .....                  | 187 |
| Printing-related troubleshooting .....               | 189 |
| The media is jammed .....                            | 193 |
| <br>   |     |
| Specifications of this product .....                 | 196 |
| List of specifications .....                         | 196 |
| <br>   |     |
| Options / Supply list .....                          | 199 |
| <br>   |     |
| Revision History .....                               | 200 |





# Messages and Error Messages



This section describes messages displayed during normal printer operation or when errors occur, and solutions to the messages.

## Status messages

This section describes messages displayed during printer normal operation.

When the product is operating correctly, each operation status is displayed on the front panel as below.

| Display                                | Description   |
|--|---|
| Ready to Print<br>PG: Low1 W: XXXX mm  | Standby (Media is loaded).  |
| Media End<br>PG: Low1                  | Standby (Media is not loaded).<br> <a href="#">"Loading a roll media" P. 25</a>  |
| Receiving<br>PG: Low1 W: XXXX mm       | Receiving data.   |
| Converting<br>PG: Low1 W: XXXX mm      | Analyzing data.   |
| Printing<br>PG: Low1 W: XXXX mm        | Under printing.   |
| Remain: XXX.Xm                         | Displays the length of the data that has not been printed in meters for the data currently being printed.   |
| Remain Time: XXX.Xmin                  | Displays the time remaining to print in minutes for the data currently being printed.   |
| Media Remain: XXX m                    | Displays the remaining length of the media currently set in meters.   |
| Pausing Print<br>Cancel Print -> Enter | Pausing printing.<br><ul style="list-style-type: none"> <li>• Tap  (Cancel) to resume printing.</li> <li>• Tap  (Enter) to cancel the print job.</li> </ul> |
| Warming Up                             | Warming up Heater.  |
| Warming Up<br>Skip -> Enter            | Received the printing data while Heater is warming up.<br>To start printing before Heater is warmed up, press the  (Enter) key.  |
| Cleaning **%                           | Cleaning.<br>Please wait a while.   |
| Auto nozzle checking                   | When the optional drop sensor unit is installed:<br>Auto Nozzle Checking.<br>Please wait a while.   |
| Ink Refill **%                         | Charging the ink.<br>Please wait a while.   |
| SubTank Refill **%                     | Charging the subtank.<br>Please wait a while.   |







| Display                                | Description  |
|--|--|
| Busy-Washing                           | <ul style="list-style-type: none"> <li>Initial charging, ejecting filler fluid.</li> <li>Washing the print head by cleaning fluid.</li> </ul> Please wait a while.   |
| During discharge                       | Flushing ink from the print head in the head cleaning process.<br>Please wait a while.   |
| User: Type ** OK?                      | Initializing the media.<br>Please wait a while.  |
| Media Initial                          | (** represents the set User type.)   |
| Move To Origin Position                | The print head is moving to the print start position to check the print origin<br>Please wait a while.   |
| Confirm Position<br>End -> Enter       | The print head has moved to the print start position. If it shows the intended position, tap  (Enter).  |
| Power Off                              | Turning OFF the printer. Wait for a while.   |
| Insert Ink Bags                        | Charging the ink. Insert ink bag cases.  |
| Insert Cleaning Bags                   | Washing Print head. Install cleaning bags.   |
| Remove Bags                            | Washing Print head or discharging ink.<br>Remove ink bag cases.  |
| Empty Waste Ink Tank<br>then Tap Enter | The waste ink tank became full during initial filling.<br>Empty the waste ink tank and then tap the  (Enter).  |
| S/C Reading                            | Reading the S/C card.  |
| *** Remote Mode ***<br>End -> Enter    | The remote panel mode is running, via MSM or similar. In the remote panel mode, operations via the front panel are not possible. To terminate the remote panel mode, press the  (Enter) key for more than two seconds. |
| Roll Remain Error                      | The remaining roll paper count has become 0. (Printing stops)  |
| Roll Near End: *m                      | The remaining roll paper count is almost 0. The remaining roll paper is *m.  |
| Life Times [Pump*]<br>OK -> Enter      | The operational life of the pump motor has almost expired.<br>(Continues operation)<br>Contact your local MUTOH dealer.  |
| Life Times [CR Motor]<br>OK -> Enter   | The operation life CR motor has almost expired.<br>(Continues operation)<br>Contact your local MUTOH dealer.   |
| Life Times [PF Motor]<br>OK -> Enter   | The operational life of the PF motor has almost expired.<br>(Continues operation)<br>Contact your local MUTOH dealer.  |











## Error message display and remedies





This section describes error messages and remedies.

Error messages are displayed when certain failures occur during printer operation.

If an error that can be displayed occurs, the printer may display the following error messages on the front panel and stop operation.

| Display                                  | Description   |
|--|---|
| Cover Open                               | Any or all of covers (front cover, maintenance cover right, maintenance cover left) are open.<br>Close the cover.   |
| Put Lever Back                           | The pressure rollers is released. Lower the pressure rollers.   |
| Hold Media                               | The media is not loaded.<br>Load the media.<br> <a href="#">"Loading a roll media" P. 25</a>   |
| Undefined Media                          | Media detection has failed. (Stops operation)<br>Reload the media.  |
| Media Slant                              | Media is fed obliquely. (Stops operation)<br>Reload the media.  |
| Media Cut Error                          | The media was not cut. (Stops operation)  |
| Change Head Gap ***<br>PG: *** W: ****mm | The head height on the printer does not match with the one specified on the print data.<br> <a href="#">"Printhead Height" P. 46</a> |
| End Of Roll                              | The Media has run out. (Stops operation)<br>Load a new media.<br> <a href="#">"Loading a roll media" P. 25</a>                       |
| [*****] Ink End                          | Ink has run out. (Stops operation)<br>Replace with a new ink bag.<br> <a href="#">"Replacing ink bag" P. 142</a>                     |
| [*****] No Bag                           | Ink bag case is not inserted. (Stops operation)<br>Insert Ink bag case.   |
| [*****] No S/C Card                      | S/C card is not inserted. (Stops operation)<br>Insert S/C card.   |
| [*****] S/C Ink Low                      | Slot * ink is low.<br>Get a replacement bag ready.  |
| [*****] S/C Ink End                      | Ink has run out. (Stops operation)<br>Replace with a new ink bag.<br> <a href="#">"Replacing ink bag" P. 142</a>                     |
| [*] Chg. S/C Card                        | Replace with a new S/C card.  |
| [*****] Discharged                       | Ink is not filled.<br>Perform initial ink charging.<br> <a href="#">"Performing initial charging after head cleaning" P. 174</a>     |
| Full WasteInkTank                        | The waste ink tank is full. (Stops operation)<br>Immediately empty the tank.<br> <a href="#">"Emptying waste ink tank" P. 145</a>    |
| [*****] S/C ReadErr                      | Reading S/C Card has been failed.<br>Insert S/C Card again.   |

| Display                                    | Description  |
|--|--|
| [*****] S/C Col.Err                        | Ink bag cases are inserted in wrong slots.<br>Insert ink bag cases correctly again.  |
| [*****] S/C Ink Err                        | The ink bag cannot be used for this printer.<br>Contact your local MUTOH dealer.   |
| [*****] S/C CodeErr                        | Inserted ink bag is not a proper one.<br>Contact your local MUTOH dealer.  |
| [*****] Broken Chip                        | S/C Card has been broken.<br>Insert new ink bag.   |
| Cannot Operate<br>Outside Print Area       | The printer is unable to print because there is not enough printable width on the media.<br>Adjust printable width by changing CR origin and side margin (left and right side margin) settings.<br> <a href="#">"Setup 5: Media Width" P. 90</a> , <a href="#">"Setup 8: Origin" P. 93</a> , <a href="#">"Setup 3: Side Margin" P. 89</a><br><br>Printable width needed varies depending on the types of test print. Adjust the above settings to secure enough width.<br> <a href="#">"***&gt;2: Adjust Print" P. 75</a> (at least 550 mm)<br> <a href="#">"***&gt;3: PF Adjust" P. 81</a> (at least 400 mm)<br> <a href="#">"Test Print 6: Adjust Head" P. 112</a> (at least 550 mm)<br> <a href="#">"Roll Length Manage1: Print" P. 127</a> , <a href="#">"Roll Length Manage2: Simple Print" P. 127</a> (at least 400 mm) |
| Cannot Operate<br>Media Initial - Off      | Because the "Media Initial" menu is set to "Off", the "Auto Print" menu cannot be selected.<br> <a href="#">"Setup 4: Media Initial" P. 90</a><br>Set the "Media Initial" menu to "Top&Width" or "Width", and then select the "Auto Print" menu.<br> <a href="#">"Roll Length Manage6: Auto Print" P. 131</a>  |
| Cannot Operate<br>No Media                 | The media is not loaded.<br>Load the media.<br> <a href="#">"Loading a roll media" P. 25</a>  |
| Cannot Operate<br>Roll Length - Off        | The printer is unable to print because the "Roll Length" setting is set to "Off".<br> <a href="#">"Roll Length Manage4: Roll Length" P. 129</a><br>Specify the "Roll Length" settings and then select Print or Simple Print.<br> <a href="#">"Roll Length Manage1: Print" P. 127</a> , <a href="#">"Roll Length Manage2: Simple Print" P. 127</a>  |
| Cannot Operate<br>Output Mode - Take Up    | The printer is unable to scan because Output Mode is set to "Take Up".<br> <a href="#">"Setup 6: Output Mode" P. 91</a><br>Switch Output Mode to "Off" and then select the Scan menu.<br> <a href="#">"Roll Length Manage3: Scan" P. 128</a>   |
| Drop Sensor Failed<br>Auto NozzleCheck Off | When the optional drop sensor unit is installed:<br>Due to the drop sensor unit failure, the auto nozzle check function was switched to "Off".<br> <a href="#">"Setup 26: Auto Nozzle Check (Requiring the optional drop sensor unit)" P. 105</a><br>Contact your local MUTOH dealer.   |

| Display                                  | Description   |
|--|---|
| Auto Nozzle Check<br>Nozzle Clog Present | <p>When the optional drop sensor unit is installed:<br/>The printer run an auto cleaning cycle to recover blocked nozzles that an auto nozzle check detected, but the nozzles are still clogged.</p> <p> <a href="#">"Setup 26: Auto Nozzle Check (Requiring the optional drop sensor unit)" P. 105</a></p> <p>Tapping  (Enter) key will clear the message.</p> <p>Manually run a nozzle check and cleaning cycles.</p> <p> <a href="#">"Nozzle check" P. 36</a>, <a href="#">"Cleaning" P. 38</a></p> |
| Temperature too low                      | <p>Printer's temperature is too low. Adjust room temperature. Wait until the warning message is no longer displayed.</p> <p> <a href="#">"Specifications of this product" P. 196</a></p>   |
| Temperature too high                     | <p>Printer's temperature is too high. Adjust room temperature. Wait until the warning message is no longer displayed.</p> <p> <a href="#">"Specifications of this product" P. 196</a></p>  |

 **Note**

- "\*\*\*\*" in the message "Change Head Gap \*\*\*\*" represents the head height (High, Middle, Low2, or Low1).
- [\*\*\*\*\*] in the error message indicates the target ink cartridge slot.
- If "Ink End" or "No S/C Card" and "No Bag" occur at the same time, "No Bag" message has priority to be displayed.

## Smartchip recovery

---

When the following message is prompted on the operation panel, a smartchip error such as broken chip may have occurred in the S/C card.

Check that the correct color is inserted in the cartridge slot and perform smartchip recovery.

This will allow you to continue to print.

To perform smartchip recovery, do one of the followings according to the message appeared.

| Display                                    | Description  |
|--|--|
| [*****] S/C Recog. E                       | The S/C card that needs smartchip recovery may have been installed.<br>Remove the S/C card and insert it again.<br>If the printer is still unable to read it, insert a new S/C card. <ul style="list-style-type: none"><li>• If a message "[*****] Check Color OK -&gt;Enter" appears after the S/C card is reinserted, follow the message "[*****] Check Color OK -&gt;Enter" to operate.</li></ul>   |
| [****] Check Color<br>OK           ->Enter | The S/C card that needs smartchip recovery may have been installed.<br>Check that the ink color of the S/C card inserted is correct. <ul style="list-style-type: none"><li>• In case of wrong color insertion, insert a correct S/C card.</li><li>• If color is correct, tap  (Enter). The printer will perform smart chip recovery and will continue to print.</li></ul> |
| [*] Chg. S/C Card                          | The ink bag that smartchip recovery was performed has run out of ink.<br>Replace with a new S/C card.  |

### Note

- [\*] in the error message indicates the target ink cartridge slot.
- During smartchip recovery execution, the ink cartridge being recovered blinks in the ink status menu.

 ["Ink Status" P. 118](#)

## Error requiring restart

An error requiring restart is displayed if a fatal operational failure such as the following occurs.

- When an obstacle that prevents printing occurs.
- When a problem occurs with the electrical circuit (PCB, motor, sensor, etc.) of the printer.
- When a failure in the printer control program occurs.

If an error requiring restart occurs, the printer stops operating after performing the following operations.

1. The drive power automatically shuts down.
2. All lamps on the front panel blink, and the buzzer rings continuously.
3. The error message is displayed on the front panel.

Pressing any key on the front panel stops the beeping.

For an error requiring restart, operation will return to normal after removing the cause of the error and restarting the printer.

If the same error continues to be displayed, contact the your local MUTOH dealer.

Be sure to tell us the code no. of the error message when you contact us.

| Display     | Description  |
|-------------|--|
| E***Err [ ] | <p>A problem that does not have a remedy has occurred.</p> <ol style="list-style-type: none"><li>1. Remove obstacles such as paper scraps in the drive system.</li><li>2. Confirm that the replaced items are correctly attached.</li><li>3. Turn the power button off. Wait a short while, then turn the power button on, to restart the printer.</li></ol> |

### Important!

**When an error requiring reboot occurs, the printer cannot be turned off from the setup menu in the control panel. Press the power button for more than 2 seconds to turn off the printer.**

### Note

- "\*\*\*\*" in the error message is the code no. that indicates what type of error occurred.
- The command code representing the error occurred may be indicated in [ ].



# Troubleshooting

This section describes undisplayed malfunctions and failures of the printer, possible causes and countermeasures.

## Note



- The current status and error information of your printer can be checked from the Printer Status tab > Status Information on MSM.  
If your printer is not operating correctly, check this Status Information first.
- Make sure to use the latest version of MSM.  
To check the latest available version, go to Help > Version > Check for updates on MSM.  
If old version is installed in your computer, download the latest version from MUTOH Club.  
 MUTOH Status Monitor Operation Manual

## Installation and initial setup troubleshooting





| Description  | Possible cause and Remedy  |
|--|--|
| <b>Cannot perform the initial inkcharging.</b>           | <b>Is the front cover, or the maintenance cover open?</b> <ul style="list-style-type: none"> <li>• Close the front cover, or the maintenance cover.</li> </ul>   |
|  | <b>Is the media loading lever raised?</b> <ul style="list-style-type: none"> <li>• Lower the media loading lever.</li> </ul>   |
|  | <b>Are ink bag cases and S/C cards inserted all the way into the printer?</b> <ul style="list-style-type: none"> <li>• Make sure ink bag cases and S/C cards are all inserted properly.<br/> <a href="#">"Installing the ink bag" P. 143</a></li> </ul>   |
| <b>Ink does not come out afterink charging.</b>          | <b>Is the ink bag too cold?</b> <ul style="list-style-type: none"> <li>• Leave the ink bag at room temperature for at least three hours, and perform cleaning several times.<br/> <a href="#">"Head cleaning" P. 147</a></li> </ul>   |
|  | <b>Is the power turned OFF during ink charging?</b> <ul style="list-style-type: none"> <li>• Turn the power ON again and continue ink charging.</li> </ul>   |
| <b>Nozzle clogging occurs afterinitial ink charging.</b> | <b>Did you perform head cleaning?</b> <ul style="list-style-type: none"> <li>• Perform cleaning, then, check the print result.<br/> <a href="#">"Head cleaning" P. 147</a></li> <li>• If there is no improvement in the print result even after performing cleaning, leave the printer unused for an hour or more. Then perform cleaning or "Little Charge" again and check the print result.</li> <li>• If the problem still persists, contact your local Mutoh dealer.</li> </ul> |

| Description                                     | Possible cause and Remedy  |
|---|--|
| <b>MSM or RIP cannot access to the printer.</b> | <b>Is Ethernet cable connected correctly?</b> <ul style="list-style-type: none"> <li>Securely connect the Ethernet cable to the Ethernet Port.</li> </ul>  |
|   | <b>Are the network settings configured correctly?</b> <ul style="list-style-type: none"> <li>Configure the network settings correctly.</li> </ul>  |
|   | <b>Do the printer's network settings match the computer's settings?</b> <ul style="list-style-type: none"> <li>Match this product's network settings with the computer side environment.           <ul style="list-style-type: none"> <li> <a href="#">"Connecting to a Computer" P. 13</a>, <a href="#">"Initial Settings 4: IP Address" P. 123</a>, <a href="#">"Initial Settings 5: Subnet Mask" P. 123</a>, <a href="#">"Initial Settings 6: Gateway" P. 124</a></li> </ul> </li> </ul> |

## Boot-up troubleshooting



| Symptom  | Possible cause and Remedy  |
|--|--|
| <b>Does not work at all after power activation /after loading the media.</b> | <b>Is the power cable connected to the plug?</b> <ul style="list-style-type: none"> <li>Connect the power cable.</li> </ul>  |
|  | <b>Does the AC power supply provide the specified voltage?</b> <ul style="list-style-type: none"> <li>Connect the cable to another outlet.</li> </ul>  |
|  | <b>Is the front cover, or the maintenance cover open?</b> <ul style="list-style-type: none"> <li>Close the front cover, or the maintenance cover.</li> </ul>   |
|  | <b>Is the pressure rollers released?</b> <ul style="list-style-type: none"> <li>Lock the pressure rollers.</li> </ul>  |
|  | <b>Is the media loaded correctly?</b> <ul style="list-style-type: none"> <li>Load the media correctly.           <ul style="list-style-type: none"> <li> <a href="#">"Loading a roll media" P. 25</a></li> </ul> </li> </ul>  |
|  | <b>Is the ink bag case inserted?</b> <ul style="list-style-type: none"> <li>Insert the ink bag case.</li> </ul>  |
|  | <b>Do you use the printer within recommended environmental conditions?</b> <ul style="list-style-type: none"> <li>Make sure to use the printer within the specification range.           <ul style="list-style-type: none"> <li> <a href="#">"Ensuring a suitable place for installation" of the "Startup Guide"</a></li> </ul> </li> </ul> |
|  | <b>Is there any error message displayed on MSM?</b> <ul style="list-style-type: none"> <li>Go to the Printer Status tab in MSM and check that if any error message is displayed in the Status Information.</li> </ul>  |



## Media-related troubleshooting

| Symptom  | Possible cause and Remedy  |
|--|--|
| <b>The media slips, is torn /crumpled during initialization.</b> | <b>Is the media loaded correctly?</b> <ul style="list-style-type: none"> <li>Load the media correctly.</li> </ul>  <a href="#">"Loading a roll media" P. 25</a>   |
|  | <b>Are there any foreign materials such as torn paper attached to Pressure rollers?</b> <ul style="list-style-type: none"> <li>Clean Pressure rollers.</li> </ul>  <a href="#">"Inside cleaning" P. 159</a>   |
|  | <b>Do you use the printer within recommended environmental conditions?</b> <ul style="list-style-type: none"> <li>Make sure to use the printer within the specification range.</li> </ul>  "Ensuring a suitable place for installation" of the "Startup Guide"  |
|  | <b>Are any curls or warps present on your media?</b> <ul style="list-style-type: none"> <li>Set the edge holder at both edges of the media.</li> <li>Check that you select the appropriate vacuum fan setting.</li> </ul>  <a href="#">"After loading the media..." P. 32</a> , <a href="#">"7: Vacuum Fan" P. 87</a> |
|  | <b>Are you using creased, damaged, torn or curled media?</b> <ul style="list-style-type: none"> <li>Replace the media.</li> </ul>  |
|  | <b>Is holddown pressure adequate for the roll media?</b> <ul style="list-style-type: none"> <li>Use the slide lock lever on the individual pressure rollers to reduce or cancel the pressure.</li> </ul>  <a href="#">"Canceling or reducing pressure rollers individually" P. 53</a>                               |

### Note

If the media is jammed or torn, remove it according to ["The media is jammed" P. 193](#)

| Symptom                                       | Possible cause and Remedy   |
|---|---|
| <b>The printer does not detect the media.</b> | <b>Is the media loaded correctly?</b> <ul style="list-style-type: none"> <li>Load the media correctly.</li> </ul>  <a href="#">"Loading a roll media" P. 25</a>  |
|   | <b>Is the media loaded at an angle?</b> <ul style="list-style-type: none"> <li>Load the media straight.</li> </ul>  <a href="#">"Loading a roll media" P. 25</a>   |
|   | <b>Do you use the printer within recommended environmental conditions?</b> <ul style="list-style-type: none"> <li>Make sure to use the printer within the specification range.</li> </ul>  "Ensuring a suitable place for installation" of the "Startup Guide" |
|   | <b>Did you load the media which has been printed before?</b> <ul style="list-style-type: none"> <li>Use a new media.</li> </ul>   |

| Symptom                             | Possible cause and Remedy  |
|-------------------------------------|--|
| <b>Media jams frequently occur.</b> | <p><b>Do you use the printer within recommended environmental conditions?</b></p> <ul style="list-style-type: none"> <li>• Make sure to use the printer within the specification range.</li> </ul> <p> "Ensuring a suitable place for installation" of the "Startup Guide"</p>  |
|                                     | <p><b>Are any curls or warps present on your media?</b></p> <ul style="list-style-type: none"> <li>• Set the edge holder at both edges of the media.</li> <li>• Check that you select the appropriate vacuum fan setting.</li> </ul> <p> <a href="#">"After loading the media..." P. 32</a>, <a href="#">"Vacuum Fan" P. 87</a></p> |
|                                     | <p><b>Are you using creased, damaged, torn or curled media?</b></p> <ul style="list-style-type: none"> <li>• Replace the media.</li> </ul>   |















**Note**







If the media is jammed or torn, remove it according to ["The media is jammed" P. 193](#)









| Symptom                                 | Possible cause and Remedy  |
|---|--|
| <b>The media skews during printing.</b> | <p><b>Is the media loaded correctly?</b></p> <ul style="list-style-type: none"> <li>• Load the media correctly.</li> </ul> <p> <a href="#">"Loading a roll media" P. 25</a></p> |

## Printing-related troubleshooting

| Symptom  | Possible cause and Remedy  |
|--|--|
| <b>The printer does not print.</b>                                       | <p><b>Is Ethernet cable connected correctly?</b></p> <ul style="list-style-type: none"> <li>Securely connect the Ethernet cable to the Ethernet Port.</li> </ul> <p> <a href="#">"Connecting to a Computer" P. 13</a></p>   |
|  | <p><b>Is there any error message displayed on MSM?</b></p> <ul style="list-style-type: none"> <li>Go to the Printer Status tab in MSM and check that if any error message is displayed in the Status Information.</li> </ul>   |
| <b>The carriage pauses at either side of the printer while printing.</b> | <p><b>Does your computer meets the following requirements?</b></p> <ul style="list-style-type: none"> <li>OS: Windows 11</li> <li>CPU: Intel (R) Core (TM) i5 or more</li> <li>Memory: No less than 8G byte</li> <li>Network:<br/>Use a network port that supports Gigabit Ethernet, and an Ethernet cable that supports Category 6 Gigabit Ethernet or later.</li> </ul> <p> <b>Note</b></p> <ul style="list-style-type: none"> <li>The OS support period of MUTOH software follows the Microsoft support lifecycle policies.</li> <li>When using RIP software, please also see the system requirements of your RIP software.</li> </ul>   |
|  | <p><b>Do you use a Gigabit Ethernet cable?</b></p> <ul style="list-style-type: none"> <li>To connect your printer to your computer, use a Gigabit Ethernet cable Category 6 or later.</li> </ul> <p> <a href="#">"Connecting to a Computer" P. 13</a></p>   |
|  | <p><b>Is MPS enabled?</b></p> <ul style="list-style-type: none"> <li>Check the status of MPS.</li> </ul> <p> <a href="#">"Menu 8: MPS" P. 62</a></p> <p>When set to "On":<br/>Check that your computer (specification, CPU load), Ethernet cable (specification, connectivity) and network environment meet the requirements.</p> <p>When set to "Off":<br/>In MSM, the checkbox "MUTOH Print Server (MPS)" is unchecked or "MPS Optimization" is set to "Disable". Try enabling MPS in MSM.</p> <p> <b>Note</b></p> <ul style="list-style-type: none"> <li>MPS settings can be changed in MSM.</li> </ul> |

| Symptom   | Possible cause and Remedy  |
|---|--|
| <b>Smears or missing area partially appears on the prints.</b>                            | <b>Are any curls or warps present on your media?</b> <ul style="list-style-type: none"> <li>• Set the edge holder at both edges of the media.</li> <li>• Check that you select the appropriate vacuum fan setting.</li> </ul>  <a href="#">"After loading the media..." P. 32, "***&gt;7: Vacuum Fan" P. 87</a> |
|   | <b>Does the printer heater deform your media?</b> <ul style="list-style-type: none"> <li>• If the heater deforms the media loaded to the printer before printing, go to the "Start Feed" menu to increase the media feeding amount.</li> </ul>  <a href="#">"Setup 23: Start Feed" P. 103</a>                   |
|   | <b>Does the media contain moisture or are you using the creased or wrinkled media?</b> <ul style="list-style-type: none"> <li>• Replace it with the new media.</li> </ul>  |
|   | <b>Is there any dirt around the print head?</b> <ul style="list-style-type: none"> <li>• Clean the circumference of the print head.</li> </ul>  <a href="#">"Cleaning around the print head" P. 155</a>   |
| <b>The printing position is incorrect (some parts of the media cannot be printed on).</b> | <b>Is the media loaded correctly?</b> <ul style="list-style-type: none"> <li>• Load the media correctly.</li> </ul>  <a href="#">"Loading a roll media" P. 25</a>   |
|   | <b>Did you set up the origin?</b> <ul style="list-style-type: none"> <li>• Cancel or reset the settings of the origin.</li> </ul>  <a href="#">"Setup 8: Origin" P. 93</a>   |
| <b>Printing is blurred.</b>   | <b>Is the media printed on the printing surface?</b> <ul style="list-style-type: none"> <li>• Check the printing surface of the media and set it correctly.</li> </ul>   |
|   | <b>Did you perform Print quality adjustment?</b> <ul style="list-style-type: none"> <li>• Perform Print quality adjustment.</li> </ul>  <a href="#">"***&gt;2: Adjust Print" P. 75</a>  |
|   | <b>Did you perform Media feed adjustment?</b> <ul style="list-style-type: none"> <li>• Perform Media feed adjustment.</li> </ul>  <a href="#">"***&gt;3: PF Adjust" P. 81</a>   |

| Symptom  | Possible cause and Remedy   |
|--|---|
| <p><b>White or black lines appear on printed media.</b></p>              | <p><b>Is the media loaded correctly?</b></p> <ul style="list-style-type: none"> <li>• Load the media correctly.</li> </ul> <p> <a href="#">"Loading a roll media" P. 25</a></p>  |
|  | <p><b>Does the media contain moisture or are you using the creased or wrinkled media?</b></p> <ul style="list-style-type: none"> <li>• Replace it with the new media.</li> </ul>  |
|  | <p><b>Are Nozzles in good condition?</b></p> <ul style="list-style-type: none"> <li>• Perform Nozzle check.</li> <li>• Then if nozzle clogging is found, conduct cleaning.</li> </ul> <p> <a href="#">"Nozzle check and cleaning" P. 35</a></p>  |
|  | <p><b>Did you perform Print quality adjustment?</b></p> <ul style="list-style-type: none"> <li>• Perform Print quality adjustment.</li> </ul> <p> <a href="#">"***&gt;2: Adjust Print" P. 75</a></p>   |
|  | <p><b>Did you perform Media feed adjustment?</b></p> <ul style="list-style-type: none"> <li>• Perform Media feed adjustment.</li> </ul> <p> <a href="#">"***&gt;3: PF Adjust" P. 81</a></p>  |
| <p><b>Printing lines are not straight/ are duplicated or patchy.</b></p> | <p><b>Are Nozzles in good condition?</b></p> <ul style="list-style-type: none"> <li>• Perform Nozzle check.</li> <li>• Then if nozzle CLOGGING is found, conduct cleaning.</li> </ul> <p> <a href="#">"Nozzle check and cleaning" P. 35</a></p>   |
|  | <p><b>Did you perform Print quality adjustment?</b></p> <ul style="list-style-type: none"> <li>• Perform Print quality adjustment.</li> </ul> <p> <a href="#">"***&gt;2: Adjust Print" P. 75</a></p>   |
|  | <p><b>Did you perform Media feed adjustment?</b></p> <ul style="list-style-type: none"> <li>• Perform Media feed adjustment.</li> </ul> <p> <a href="#">"***&gt;3: PF Adjust" P. 81</a></p>  |
|  | <p><b>Is Ink bag within the validity period?</b></p> <ul style="list-style-type: none"> <li>• Use a non-expired ink bag.</li> </ul>   |
| <p><b>Printed color is not accurate.</b></p>                             | <p><b>Are Nozzles in good condition?</b></p> <ul style="list-style-type: none"> <li>• Perform Nozzle check.</li> <li>Then if nozzle CLOGGING is found, conduct cleaning.</li> </ul> <p> <a href="#">"Nozzle check and cleaning" P. 35</a></p>  |
|  | <p><b>Did you install an ink bag on each ink pack case with correct ink color of S/C card?</b></p> <ul style="list-style-type: none"> <li>• Check that the ink color written on S/C card matches the ink color of ink bag installed on each ink pack case.</li> <li>• If it does not match, perform "Longstore" to clean the print head and then perform initial ink charging.</li> </ul> |

| Symptom  | Possible cause and Remedy  |
|--|--|
| <p><b>Nozzle clogging remains after head cleaning.</b></p> | <p><b>Is there any ink stains or deposits on the cleaning wiper or circumference of the print head?</b></p> <ul style="list-style-type: none"> <li>• Clean the cleaning wiper and circumference of the print head.</li> </ul> <p> <a href="#">"Cleaning of cleaning wiper" P. 150, "Cleaning around the print head" P. 155</a></p>  |
|  | <p><b>Do you use the appropriate type of cleaning wiper for the head height?</b></p> <p>See the following section for the appropriate combination.</p> <p> <a href="#">"Replacing with an appropriate cleaning wiper for the head height" P. 49</a></p>   |
|  | <p><b>Did you select an appropriate cleaning setting?</b></p> <ul style="list-style-type: none"> <li>• Head Select: Select "ALL" or the print head which nozzle Clogging occurs.</li> </ul> <p> <a href="#">"Menu3: Cleaning" P. 116</a></p> <ul style="list-style-type: none"> <li>• Cleaning Mode: If nozzle clogging still persists after attempting Normal Cleaning or Long Cleaning two or three times, perform "Little Charge".</li> </ul> <p> <a href="#">"Menu3: Cleaning" P. 116</a></p> <ul style="list-style-type: none"> <li>• Select Nozzle: If Little Charge does not recover the nozzles, go to Select Nozzle and select the nozzles that are firing properly.</li> </ul> <p> <a href="#">"Setup 21: Select Nozzle" P. 101</a></p> |
|  | <p><b>Is it time to replace the cleaning wiper or absorption material for the flushing box?</b></p> <ul style="list-style-type: none"> <li>• Check the status of the cleaning wiper and absorption material for the flushing box.</li> <li>• Replace them if they meet the criteria for replacement.</li> </ul> <p> <a href="#">"Replacing absorption material for the flushing box" P. 160, "Replacing the cleaning wiper" P. 164</a></p>  |
| <p><b>Printed area does not dry completely.</b></p>        | <p><b>Do you use the heaters of the printer?</b></p> <ul style="list-style-type: none"> <li>• Check the settings of heaters.</li> </ul> <p> <a href="#">"***&gt;4: Preheater" P. 86, "***&gt;5: Platen Heater" P. 86, "***&gt;6: Dryer" P. 86</a></p>   |
|  | <p><b>Did you select an appropriate print mode?</b></p> <ul style="list-style-type: none"> <li>• Check that the print mode is set to the appropriate mode.</li> </ul> <p> <a href="#">"***&gt;1: Print Mode" P. 73</a></p>  |

 **Note**



- If an image contains high ink density area, the area may not dry easily.
- Depending on the media being used, printed area may not dry easily.

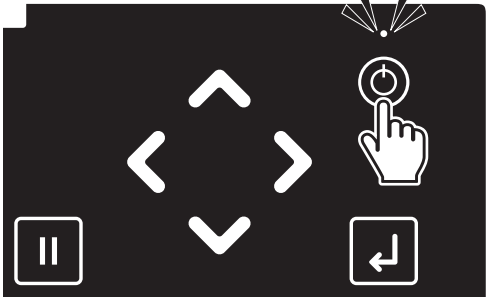

## The media is jammed

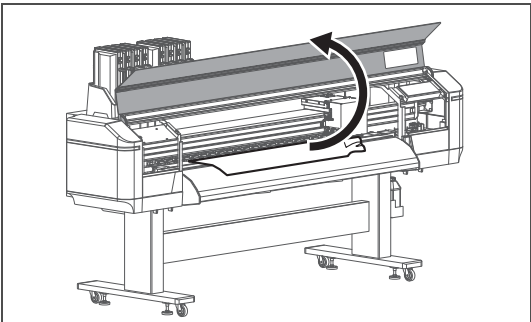
When the media is jammed in the printer, follow the procedure below to remove it.

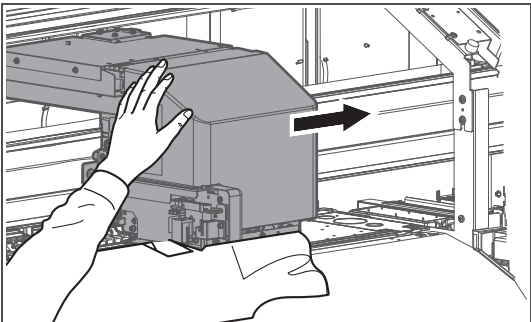
- [1] 
- Long press the Power button.
- This product starts its powering off operations.
  - When the message "Power Off" appears on the panel, release the Power button.
  - The Power LED lights off.

- [2] 
- Open the front cover.

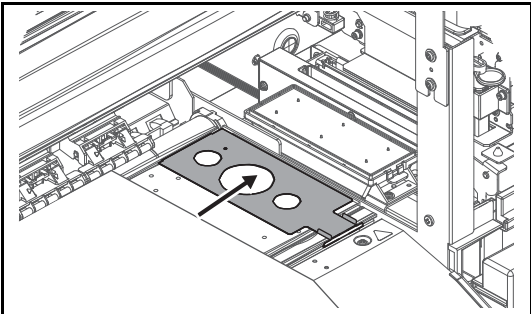
- [3] 
- Move the carriage from the top of the media to the right.
-  **Important!**
- When the head height is set to Low1 or Low2, change it to High and then shift Head.**
- After shifting Head, change the setting back to Low1 or Low2.**
-  ["Printhead Height" P. 46](#)

- [4] 
- Slide the edge holder to the right to remove it from the media.
-  **Important!**
- If any deformation is found on the media holder, stop using it and contact your local MUTOH dealer.**

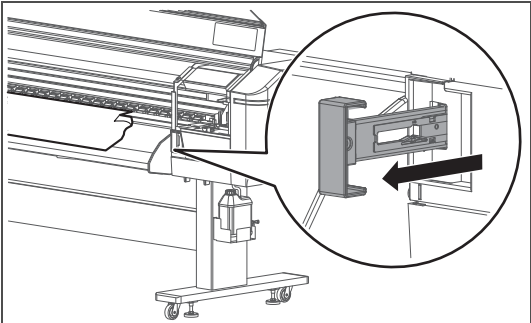
- [5] 
- From the front side of the printer, pull the media feed lever towards you to release the pressure rollers.

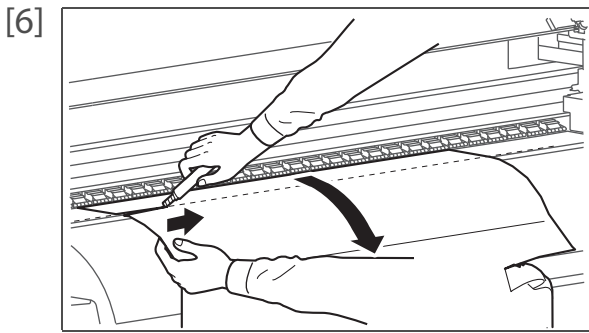

[6] Pull the media towards you and use a cutter to cut the torn part of the media along the groove.

[7] Rewind the media a little by rolling Flange on the media holder.

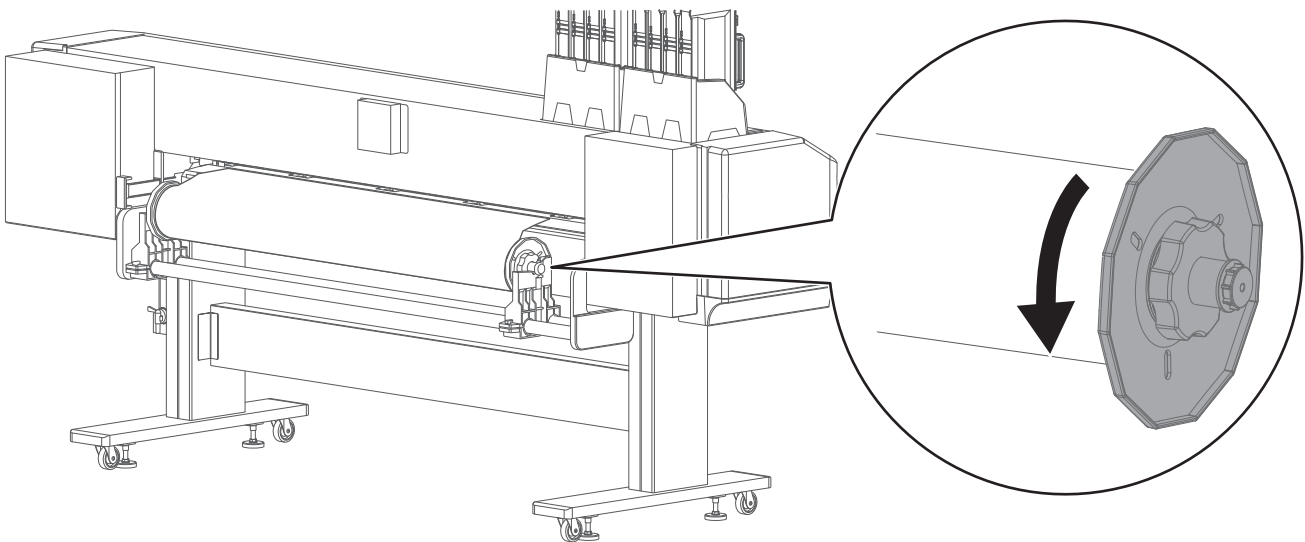

[8] If paper dust or pieces of paper remain inside the printer, remove them.

[9] Turn the printer ON.

[10] Load a roll media for Nozzle check.

["Loading a roll media" P. 25](#)

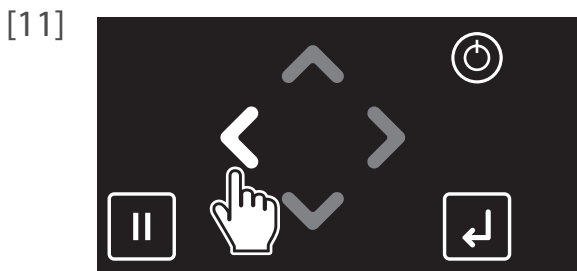

[11] Tap .

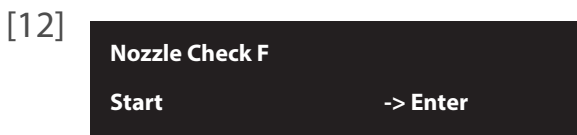

[12] Tap (Enter).

• The printer will print the nozzle check pattern.

[13] Check the nozzle check print to see all nozzles are clear.

- If you find missing or thin lines on the print, go to ["Cleaning steps" P. 38](#).
- If all lines are clearly printed, you can start printing.

Note



## Specifications of this product

### List of specifications

|                            |   |  |
|----------------------------|---|--|
| Model Name                 | XPJ-1682SR-P  |  |
| Print method               | On demand piezo method  |  |
| Drive method               | Firmware servo/DC motor drive   |  |
| Media feed method          | Multipoint pressurizing Grid roller system                            |  |
| Media hold down system     | Pressure roller down system by manual lever                           |  |
| Conditions of usable media | Media outer diameter  | Φ200 mm or less  |
|                            | Media core diameter   | 2 inches or 3 inches   |
|                            | Weight  | 30 kg or less  |
|                            | Width   | 500 mm to 1,625 mm   |
|                            | Recommended media thickness   | 1.0 mm or less   |
| Maximum Printable Width    | 1,615 mm  |  |
| Maximum print length       | 1,500 m   |  |
| Head height adjustment     | Four-level adjustment of Low1, Low2, Middle, and High                 |  |
| Interface                  | Gb-Ethernet (1000BASE-T)  |  |
| Waste ink tank             | 2,000 ml tank is attached to the printer. Empty the tank when needed. |  |
| Ink                        | Color   | 4 colors (Black, Cyan, Magenta, Yellow)<br>8 colors (Black, Cyan, Magenta, Yellow, Light Cyan, Light Magenta, Light Black, Orange) |
|                            | Type  | 300 ml / 1,000 ml ink bag (Cleaner is 300ml)   |

|                             |   |  |
|-----------------------------|---|--|
| Environmental conditions    | Printer Operation Environment                 | Temperature 20 to 32 °C<br>Humidity 40 to 60%, No condensation   |
|                             | Recommended Printing Environment              | Temperature 22 to 30 °C<br>Humidity 40 to 60%, No condensation   |
|                             | Change rate                                   | Temperature: No more than 2 °C per 1 hour<br>Humidity: No more than 5% per 1 hour  |
|                             | Printer Storage Environment                   | Storage without ink charging: up to 6 months<br>Temperature -20 to +60 °C<br>Humidity 20 to 80%, No condensation<br><br>Storage with ink charging (when using MS41 ink): Up to 1 week<br>Temperature -10 to 40 °C<br>Humidity 20 to 80%, No condensation<br>Storage up to 4 days maximum when stored between 32 °C to 40 °C.   |
|                             | Ink Storage Environment (when using MS41 ink) | <ul style="list-style-type: none"> <li>• Black/Cyan/Magenta/Yellow/Light Cyan/Light Magenta/Light Black (300 ml or 1,000 ml each)</li> <li>• Orange (300 ml)<br/>Temperature -20 to 40 °C<br/>Humidity 5 to 85%, No condensation<br/>Keep the product in a cool, dark and well ventilated area.<br/>Keep the product away from inflammable materials or heat source.<br/>Storage under 40°C should be within one month.</li> <li>• Cleaning bag (300 ml)<br/>Temperature -5 to 40 °C<br/>Humidity: up to 80%, No condensation<br/>Storage up to 6 months maximum when stored between -5 °C to 5 °C or 30 °C to 40 °C.</li> </ul> |
| Power supply specifications | Printer:                                      |  |
|                             | Voltage                                       | AC 100V to 120V ±10%<br>AC 200V to 240V ±10%   |
|                             | Frequency                                     | 50/ 60Hz ±1Hz  |
|                             | Current                                       |  |
|                             | AC 100V to 120V                               | 9.0 A or below   |
|                             | AC 200V to 240V                               | 6.0 A or below   |
|                             | Heater:                                       |  |
| Voltage                     | AC 100V to 120V ±10%<br>AC 200V to 240V ±10%  |  |
| Frequency                   | 50/ 60Hz ±1Hz                                 |  |
| Current                     |   |  |
| AC 100V to 120V             | 10.0 A or below                               |  |
| AC 200V to 240V             | 5.0 A or below                                |  |

|                   |  |   |
|-------------------|--|---|
| Power consumption | Power off                                  |   |
|                   | Printer:                                   |   |
|                   | AC 100V to 120V                            | 1.0 W or below  |
|                   | AC 200V to 240V                            | 3.8 W or below  |
|                   | Heater:                                    |   |
|                   | AC 100V to 120V                            | 0.1 W or below  |
|                   | AC 200V to 240V                            | 0.2 W or below  |
|                   | Standby<br>(Heater: OFF)                   | 45 W or below   |
|                   | (Heater: ON)                               | 1,200 W or below  |
|                   | Sleep Mode                                 | 30 W or below   |
|                   | Operation                                  | <ul style="list-style-type: none"> <li>• Printer<br/>1,100 W or below</li> <li>• Heater<br/>1,200 W or below</li> </ul> |
| Dimensions        | Height                                     | 1,428 mm  |
|                   | When installing 1,000 ml ink<br>bag cases: | 1,611 mm  |
|                   | Width                                      | 2,770 mm  |
|                   | Depth                                      | 895 mm  |
|                   |  |   |
| Weight            | Main body                                  | 141 kg  |
|                   | Stand                                      | 32 kg   |

## Options / Supply list

For more information about the options and the supply items, contact your local MUTOH dealer.



**MUTOH strongly recommends to use genuine ink bags.  
This printer is designed to bring out the best performance when using with the MUTOH genuine ink.  
Non-MUTOH ink may cause print defects or damage to the printer.**

## Revision History

| Date    | Version | Manual code      | Supported Firmware |
|---------|---------|------------------|--------------------|
| 2022.11 | 00      | XPJ1682SRPE-A-00 | V.1.01             |
| 2022.12 | 01      | XPJ1682SRPE-A-01 | V.1.01             |
| 2024.6  | 02      | XPJ1682SRPE-A-02 | V.1.04             |
| 2024.12 | 03      | XPJ1682SRPE-A-03 | V.1.06             |
| 2025.10 | 04      | XPJ1682SRPE-A-04 | V.1.07             |
| 2026.03 | 05      | XPJ1682SRPE-A-05 | V.1.07 or later    |



**MUTOH**